



**AUSTRALIAN  
CLAY TARGET  
ASSOCIATION INC.**

---

**SHOOTING RULES**

---

**TRAP  
ISSF  
SKEET  
ACTA 5 STAND SPORTING  
ACTA ENGLISH SPORTING  
ACTA SPORTRAP**

Revised January 2020

## **PREFACE**

*These Australian Clay Target Association Shooting Rules have been compiled for the guidance of officials and the regulation of clay target shooting to ensure fair, equitable and ethical competition. They are the result of many years of experience at all levels of our sport and are reviewed at biannual intervals to ensure continual relevance.*

*An important point often missed by club officials is that membership of the ACTA is a contractual relationship which obliges members to abide by the requirements of the ACTA constitution, by-laws, rules and policies.*

*Therefore these rules must be interpreted within the context of applicable ACTA by-laws and policies which are listed on the ACTA website <https://www.claytarget.com.au> .*

*Officials are urged to familiarise themselves with the relevant ACTA by-laws and policies particularly the:*

*Member Protection Policy*

*Social Media/Cyber Bullying Policy.*

### **Awards defined in the ACTA Rule book:**

*These ACTA rules are the property of the Australian Clay Target Association and only apply to ACTA events conducted by the ACTA or authorised events in accordance with the Rules and Constitution.*

# ACTA RULES SUPERVISORS

## NATIONAL RULES SUPERVISOR

Mr Jim Shepherd  
Ph: 0427 501 336  
Email: nat.rules@claytarget.com.au

## NEW SOUTH WALES:

Mr Fred Rapley  
Ph: 0408 621 509  
Email: fred\_mary\_rapley@bigpond.com

Mr Colin Kneebone  
Ph: 0428 249 099  
Email: colin.kneebone@claytarget.com.au

## NORTHERN TERRITORY

Mr Rob Fox  
Ph: 0409 672 902  
Email: remfox@westnet.com.au

Mr Ray Niven  
Ph: 0438 873 790  
Email: raymeg1@bigpond.com

## QUEENSLAND

Mr Brian Muirson  
Ph: 0419 776 608  
Email: brian.muirson@claytarget.com.au

Mr Michael Swale  
Ph: 0418 763 168  
Email: mike.s.qss@bigpond.com

## SOUTH AUSTRALIA

Mr Barry Pobke  
Ph: 08 8572 3813  
Email: bapobke@bigpond.com

Mrs Deserie Baynes  
Ph: 0417 870 745  
Email: deserie.baynes60@gmail.com

## TASMANIA

Mr Mark Dennis,  
Ph: 0427 755 128  
Email: joanne.dennis@fonterra.com

Mr Stuart Browning  
Ph: 0409 218 530  
Email: stuartbrowning@bigpond.com

## VICTORIA

Mr Chris Brown  
Ph: 0433 000 482  
Email: brownie56@iprimus.com.au

Mr Peter Beaman  
Ph: 0428 178 820  
Email: peterbeaman@bigpond.com

## WESTERN AUSTRALIA

Mr Terry Marsden  
Ph: 0439 635 551  
Email: terry.marsden@claytarget.com.au

Mr Shane O'Brien  
Ph: 0407 727 770  
Email: shaneobrien@westnet.com.au

# CONTENTS

<b>TRAP</b>	<b>3</b>
Index	4
Mandatory Requirements for Officials	9
Shooting Rules	12
Handicapping / Grading	24
Competition Conditions	29
Administration	37
<b>ISSF</b>	<b>51</b>
Index	52
Mandatory Requirements for Officials	53
Shooting Rules	54
Grading	54
Competition Conditions	56
<b>SKEET</b>	<b>59</b>
Index	60
Mandatory Requirements for Officials	64
Shooting Rules	67
Handicapping / Grading	77
Competition Conditions	81
Administration	85
<b>ACTA 5 STAND SPORTING</b>	<b>101</b>
Index	102
Mandatory Requirements for Officials	106
Competition Rules	108
Grading	116
Administration / Management	119
<b>ACTA ENGLISH SPORTING</b>	<b>131</b>
Index	132
Technical Rules	133
<b>ACTA SPORTRAP</b>	<b>139</b>
Index	140
Technical Rules	141

---

**TRAP**

---

# GENERAL INDEX — TRAP

## \* MROT = Mandatory Requirements for Officials, Trap.

- Abide by result 1.10
- ACTA Record Card — handicap 2.01(a) (i) (j) (k) (m)
- ADMINISTRATION SECTION 4: 4.01 to 4.24
- Age 4.11
- Alter decision (Referee may) 1.09(d)
- Ammunition — challenge by Referee 4.18(d)
  - malfunction of 1.06(b)(v) (vi), (c)
- Appeal — against Referee's decision 4.14(c)
- Australian N.Z. Trap Championship 3.06
  - Trap teams match 3.11
  
- Bad weather 4.15(c)
- Ball Trap 1.21,
- Barrels MROT. 1 & 4.08(c)
- Barrel obstruction MROT 1
- Barrel length 4.08(c)
- Baulk 1.09
- Bet — not to make 1.02(l)
- Break recognition 4.23
  - long break records 4.24
- Broken targets — definition 1.04
  
- Cartridges 4.09
  - not to leave in gun MROT 10 & 1.01(g)
  - when to place in gun 1.02(g)
- Cash distribution 1.23
- Catching-up 4.12
- Challenge 4.14
- Champion of Champions 1.18
- Champion of Champions Cup 3.07
- Championship trophy, sash, badge 3.16
- Check Referee 4.18(b)
- Chips 1.02(j)
- Clerical error on ACTA Record Card 2.04(b) to (d)
- Common mark and handicap shooting 2.01
- Commonwealth events 3.12
- COMPETITION CONDITIONS SECTION 3: 3.01 to 3.20
  - Mackintosh International Trap Teams Match, qualifications 3.01(a) to (f)
- Competitor — competition 4.10
  - disqualified/withdraws 4.10(h)
- Continental 1.20
  
- Darkness — bad weather 4.15(c)
- Deauville Doubles 1.15

Describe event MROT 3  
 Disorderly manner 4.15(a)  
 District (club) events 3.15  
 Disturb member shooting MROT 15  
 Double barrel 1.11  
 Double rise 1.14  
 Dress 1.02(o)  
 Dusted targets 1.05

Empty shells 1.02(k)  
 Entrance fees — at Nationals 3.09  
 Event ties — trap 3.18

Fauna — not to shoot 1.01(m)  
 Firearms & loads 4.08, 4.09  
 — to remain open 1.01(e)  
 Firing point — competitor shall close gun 1.02(e)  
 — competitor to be at 1.02(a)  
 — for handicaps 4.02  
 Foot violation — competitors 1.08(e)

Gauge — not to be larger than twelve 4.08(c)  
 Grades 2.01(e)-(r)  
 Grading — for tower 1.19(e)  
 Gun — breaks down 1.08(c)  
 — not to close until result of previous shot 1.02(e)  
 — not to open MROT 14  
 — not to open after misfire 1.08(c)  
 — to be empty between lanes five & one 1.02(e)  
 — to be open 1.01(a)

Handicap — ACTA Record Card 2.01(a), (f)  
 — failure to produce 2.01(f)  
 — firing points 4.02  
 — marks 1.08(j), 2.02  
 — return to ACTA in 14 days 2.04(f)  
 — shooting 1.22

Handicappers to be appointed 2.02(a)  
 HANDICAPPING/GRADING SECTION 2: 2.01 to 2.04  
 Handicapping formula 2.02, 2.03  
 — adjustments 2.04

High-gun shoot-offs  
 — Trap 3.19

Illegal target MROT 17, 1.06(a) (note), 1.08(i)  
 Interstate teams' matches 3.17  
 Inward movement 2.03(a)  
 — physical disability 2.03(c)

Jackpots 1.23(f)

Junior 4.11(a)

Jury 4.16

Lanes — competitors to change 1.02(i)  
— to be used when two or three competitors 1.03(c)

Legal target 4.04, 4.05, 4.06

Loads 4.09

Lost target MROT 8, 1.08

Malfunction MROT 14, 1.08(f), 1.07(e)(f)

Management 4.15

— misleading 2.01(l)

Military style shotguns 4.08(d)

Misfire — malfunction 1.01(f), 1.06(b)(v), 1.08(c)

Mixed targets 1.17

Mobile Phones — not to be audible 1.01(n)

Names MROT 1

— correct name to be used 4.10(g)

National Championships

— D/B 3.02

— Deauville Doubles 3.05

— D/R 3.04

— Handicap 3.08

— Overall High Guns 3.10

— S/B 3.03

Newton Thomas J trophy O/A H/G 3.10(b)

No target 1.06

— double rise 1.07

Open shoots 4.10(a)

Orthodox gun position

— firing of gun 1.01(d)

Pieces of target 1.02(j)

Points Score 1.13

Powder — loads 1.01(j)

Practice 4.12(c)

Procedure 1.02

Pull — calling for target 1.02(c)

Reciprocol rights 4.10(i)

Red signal from trap house MROT 10, 1.01(g)

Referee

— appointment for 5 years 4.17(d)

— complaints against 4.17(c), see 4.21(e) (f)

— decision 4.17(e)

— duties of 4.18

— examiner — complaints against 4.17(c)



- examiner — duties of 4.20
  - how to become one 4.17(a)
  - may alter decision 1.09(d)
  - record to be kept by Rules Sup. 4.17(b)
  - to call result MROT 7
  - to release target immediately MROT 6
  - where to stand MROT 2
- Referee & Scorer 4.22
- Refusal rule MROT 17, 1.06(a)
- Re-handicap 2.02
- Release trigger 1.01(i), (r), 4.08(b)
- Re-registering 2.01(p)
- Ron Porter Trophy 3.10(a)
- Rules supervisor — duties of 4.21
- Safety 1.01(a) to (r)
- rule — breach of MROT 12, 1.01(k)
- Safety catch MROT 14, 1.06(b)(viii), 1.08(b)
- Sashes 3.16
- Scorer — where to stand MROT 4,
- Scorer & Referee 4.22
- Shoot Marshall — duties of 4.19
- Shooting — from wrong mark 1.08(j), 2.01(l)
- CTSN/certain events to be advertised 4.10(a) (b) (c)
  - on grounds — when not to 1.01(c)
  - lanes 4.02(a)
  - firing point 4.01
- Shooting position 1.02(f)
- SHOOTING RULES SECTION 1: 1.01 to 1.23
- Signed directive on ACTA Record Card 2.04(i) (j)
- Simultaneous discharge 1.06(b)(vi)
- Single barrel MROT 13, 1.08(d), 1.12
- Six man squad 1.03(a)
- Squad — shooters to remain as MROT 18, 1.02(m)
- Squads 1.03
- State events 3.13
- State Shoulder to Shoulder Teams Match 3.20
- Sun — no baulk 1.09(b)
- Sweepstakes deduction 1.23
- Target — different colour 1.06(b)(vii)
- illegal MROT 17, 1.08(i)
  - to be shown by Referees MROT 5
  - to be thrown 1.02(b)
  - to call for within 10 seconds 1.02(d)
- Targets 4.06
- only 2.01(a), 4.12(b), 4.13
  - squad to observe MROT 5(a), 1.02(b)
  - per trap 1.03(a) (b)
- Ties 3.18

Tower events 1.19

Tracks

- betting 1.02(l)
- people allowed on 1.02(k)
- remain on 1.02(m)

Trap

- adjustment 1.02(n)
- don't interfere with 4.18(f)
- house 4.03(a) (b)
- layout 4.01(a) (b)
- to be adjusted immediately 4.18(f)

Traps 4.07

Types of shooting 1.11 to 1.22

Underhandicapped/undergraded 2.04(g)

Unsportsmanlike 1.01(l)

- disorderly 4.15(a) (b)

Unload your guns etc MROT 19

Unregistered shooters

- not to compete 4.10(f)

Veteran 4.11(c)

Walk in front of Referee MROT 11

Walk-up 1.16

Zone events 3.14

# MANDATORY REQUIREMENTS FOR OFFICIALS, TRAP

Any reference in these rules pertaining to “him” will also mean “her”.

1. Read shooters' names from squad sheets and ensure competitors are on correct tracks and marks. For safety reasons ask all shooters to check for obstructions in barrels.
2. The Referee must stand where he has a clear view of targets and competitors, preferably between lanes 2 and 3, approximately 2 metres behind the competitor's shooting mark. If there is excessive background noise the Referee may move between lanes 2 and 4 in order to hear the competitors call so as to give all competitors equity of competition.
3. Describe the event and procedure for conduct of the event, eg “25 Target Single Barrel Championship, shot from 15 metres, 13 targets from trap 1 and 12 targets from trap 2.”
4. The Referee should ask his Scorer to stand close enough to him so that the Referee can see the score sheet, and the Scorer can observe the target as a check Referee.
5. Target to be shown by Referees,
  - (a) At the beginning of the day two (2) targets will be thrown for viewing by the squad.
  - (b) When the competitors are all in position the Referee must release a target for the first shooter to look at on his call.
    - (i) At the beginning of all events
    - (ii) After any breakdown or delay
    - (iii) At the commencement of all shoot-offs
    - (iv) On each trap used for a shoot-off
    - (v) After any break for shells etc during a shoot-off
    - (vi) If a competitor receives two broken targets in a row.
  - (c) There will be no sighter targets to be shot at by any shooter.
6. The Referee must at all times ensure that the target is released immediately on the competitor's call.
7. The Referee must clearly call the result thus: one, two, **lost target**, no target, as appropriate.
8. Lost targets must be called immediately, and the Referee must change his decision if the target breaks before it hits the ground.

9. The Referee is to see that the next shooter's gun remains fully open until the result of the previous shot has been called. He should ensure that the competitor does not call and the target released before the result has been called, refer Rule 1.01e.
10. At all times ensure that no competitor leaves a cartridge(s) in his gun after a red signal from the traphouse (breakdown etc) and when moving from lane 5 to lane 1.
11. A shooter must walk in front of the Referee when changing from lanes 1 to 5, taking care not to obstruct the Referee in the execution of his duties. From 5 to 1 he should walk behind where possible.
12. The Referee must speak to a shooter immediately on any breach of the safety rules. If the rules of etiquette are broken the Referee should speak to the shooter concerned after the squad has finished, depending on the circumstances.
13. In Single Barrel competition the Referee must ensure that one cartridge only is placed in the gun.
14. The Referee must not restore a target if the competitor opens his gun after a malfunction. In the case of a malfunction the Referee shall visually check the safety catch is not in the on position and that the action is closed. He will request the shooter to test fire the gun once only. Under no circumstances will the Referee attempt to test fire the gun.
15. The Referee should be mindful of the rule regarding squad members or spectators disturbing the competitor shooting.
16. A Referee will not call no target to deny a shooter the opportunity to shoot at a whole target unless a safety hazard exists. The shooter is the only person to decide if the target is acceptable to him.
17. Interpretation of refusal rule:
  - (a) A shooter may refuse to shoot at any target which he considers to be illegal.
  - (b) There is no limit to the number of targets the shooter may refuse as long as the Referee agrees with the reasons. Obviously, if too many targets are refused for illegality, the Referee must find the cause, then correct it. If the Referee does not consider that the target refused is illegal, he will ask the shooter why he refused the target. If the Referee is not satisfied with the reason he will tell the shooter. He will also state that any further targets which are refused, and are considered by the Referee to be legal will be scored "Lost

Target". If the above situation seems likely to arise, it is preferable that a third party, qualified if possible, adjudicates subsequent refusals. The foregoing procedure in no way discriminates against the Referee, it is meant to assist in equity of competition. A major point missed by Referees is that although a shooter may refuse to shoot at an illegal target, he is equally entitled to accept an illegal target. However, if he shoots at and misses an illegal target, the only decision open to the Referee is "Lost Target". Similarly, if he hits it "one" or "two" is scored, abide by result.

- (c) A Referee should not call "No Target" for a fast or slow released target, nor if the target seems to him to be too high, too low or too wide. "No Target" should only be called in the case of a broken target, a pair of targets emerging instead of a single (or vice versa), or where a safety hazard exists if a shooter elects to shoot at the target.
  - (d) Referees are to ensure that "R" for refusal is entered on score sheet. Every refusal must be called either "No Target" or "Lost Target" by the Referee.
18. The Referee is to see that all competitors remain as a squad until the last shooter has finished.
19. At the completion of each visit to a trap the Referee must request competitors to unload their guns and check their scores.

# SHOOTING RULES

## SECTION 1

### 1.01 SAFETY

- (a) All guns must be immediately opened upon removal from a gun rack or car to determine that they are indeed empty.
- (b) All guns carried on or about the shooting ground must be held in a position of safety, with the breech open and unloaded at all times.
- (c) Shooting on the grounds at any place other than the firing point at legitimate targets only is prohibited except where a pattern plate is installed, and then only with permission of Club Management.
- (d) Firing the gun in any position other than orthodox, ie to the shoulder, is prohibited (with the exception of a physical disability). Any shooter firing a gun from any position other than orthodox will be immediately suspended by the Club Management and reported in writing to the Executive Committee – a minimum penalty of three months suspension shall apply.
- (e) All guns must remain fully open until the result of the previous target has been called. The shooter must immediately open the gun upon having fired at his target. He must not move, attempt to turn around or move back up his shooting lane until his gun has been opened.
- (f) Shooters experiencing a misfire or malfunction must remain with their gun pointed in the direction of the traphouse until the referee arrives to adjudicate.
- (g) During any event, competitors must remove all cartridges from their guns immediately upon the red signal at the traphouse, or if any official approaches the traphouse concerned.
- (h) The competitor's gun must remain fully open until all persons on the shooting tracks have withdrawn to a handicap mark at least equal to his own.
- (i) Release trigger guns shall not be left in gun racks or in positions where they can be handled, but shall be constantly under the control and supervision of the user and shall be labelled as per Rule 4.08 (b) iii.
- (j) Powder loads for re-loads must not exceed the manufacturer's recommended specification. Shooters exceeding the recommended load shall be deemed to be in breach of the safety regulations.
- (k) Any shooter knowingly breaching any safety rule other than 1.01(d), will be immediately suspended by the Club Management for one (1) calendar month pending an investigation into their actions by the relevant State Association and the ACTA must be notified of all breaches and responses.
- (l) Any shooter committing an unsportsmanlike or unsafe act on the shooting ground shall be liable to suspension or disqualification.
- (m) Any shooter deliberately firing at any fauna on any shooting ground

shall be immediately suspended by the Club Management and shall remain suspended until the incident is dealt with by his State Association.

- (n) Mobile Phones or like devices must not be audible during competition.
- (o) Hearing and eye protection is strongly recommended for all ACTA disciplines whilst present at the firing point or trap area.
- (p) Gun sleeves and slings are not permitted to be used in any ACTA discipline.
- (q) A gun must not be used that will accept more than one gauge of cartridge at the same time and a gun must not be loaded with different gauge ammunition.
- (r) A release trigger is not to be set until the gun is mounted to the shoulder. Failure to comply will incur a warning in the first instance and disqualification from the event for a second offence.

## 1.02 PROCEDURE

- (a) A competitor must be at the firing point within two minutes of being called. Failing this he may be disqualified, penalised with loss of targets, or be re-squadded at the discretion of the club.
- (b) A target must be thrown for the first shooter on his call at his first and subsequent visit to each trap, or after a break in shooting.
- (c) When at the firing point ready for competition, the competitor shall distinctly give the command "pull" or a similar command to the Referee and thereafter the competitor is in the competition.
- (d) Once reaching his shooting mark a shooter must stand on the station, position himself, load his gun and call for his target within 10 seconds of the result of the preceding target being called by the Referee or after the Referee has given the signal to commence firing or to resume firing. Non compliance will draw a warning from the Referee, subsequent occurrences per event will be penalised one target each.
- (e) When it is his turn to shoot, a competitor shall close his gun only when at the firing point and facing the traps, he must remove the cartridge or cartridges from his gun before turning from the firing point on No. 5 lane and proceeding to No. 1 lane and shall not reload until standing on No. 1 lane. The cartridge or cartridges must be removed from any magazine gun between each lane.
- (f) The competitor must stand with both feet entirely within the boundary of the shooting station, except as allowed under Section 1.08(e).
- (g) Provided he is standing on the mark from where he is going to shoot, a competitor may place cartridges into the breech whilst he is waiting his turn to shoot.
- (h) Shooters must not close or attempt to mount the gun to the shoulder until the result of the previous shot has been called by the referee.

- (i) All competitors shall change lanes as per event conditions (eg Single or multiple targets per lane). Once having fired his shot, a competitor may move back along his own shooting lane but must not move off his shooting lane until the next competitor has fired his shot or a vacant lane exists between competitors. The next shooter on number five lane who, having removed cartridges from his gun before turning round, may proceed to number one lane, but must not re-load until he is standing on the lane. No person shall close his gun until all persons on the shooting tracks have withdrawn to a handicap mark at least equal to his own.
- (j) Unless, in the opinion of the referee, it is contrary to the equity of the competition, a competitor taking part in the competition may shoot at pieces of his own target, if he so wishes.
- (k) Empty shells on the ground must not be collected whilst shooters are on the tracks. Only those people directly associated with the competition will be on the tracks whilst the shoot is in progress.
- (l) No competitor shall make, negotiate or discuss any bet (either on his own shooting or that of any competitor) whilst he is on the shooting tracks. If any competitor infringes this rule, he may be disqualified by the referee.
- (m) All members in a squad must remain at the shooting tracks until the last competitor has shot.
- (n) The officiating referee or the Management must have the trap adjusted immediately if it is not throwing legal targets. Immediately following such alteration a target must be thrown and the competition continued.
- (o) All competitors are required to dress in an appropriate manner. The wearing of camouflage clothing (any version), singlets or singlet style sleeveless tops is prohibited. The wearing of thongs, scuffs or bare feet is prohibited. Any shoes worn must have a restraining strap or support at the heel. The wearing of high cut shorts is prohibited.

### **1.03 SQUADS**

- (a) Competitors shall be in squads with a maximum of 6; where there are withdrawals from a squad or squads after the competition has begun, squads will be closed up before each run over any trap. No. 1 competitor in each squad shall always start the shooting. The club, at its discretion, may require competitors to change starting lanes on each trap as follows: No. 1 competitor shall commence shooting from Lane 1 on Trap No. 1, Lane 2 on Trap No. 2, Lane 3 and so forth over all the traps. This rule shall also apply to double-rise.
- (b) Managements have the right to divide the number of targets by the number of traps available. For example No. 1: 15 targets, 2 traps, 1 visit. No. 1 competitor shoots 8 targets on trap No. 1, finishing on Lane 3. No. 1 competitor now starts on lane 4 on trap No. 2 and shoots 7 targets, finishing on Lane No. 5. Illustration No. 2:



30 targets, 5 traps, 6 targets per trap, one visit. Clubs must preserve equality by lane changing between traps.

- (c) Where four shooters commence in the squad, shooters will initially occupy lanes one, two, four and five. Where three shooters commence in the squad, shooters will initially occupy lanes one, three and five. Where two shooters commence in the squad, shooters will initially occupy lanes two and four. This procedure shall also apply to shoot-offs.
- (d) Squads will be filled in order of nomination. Shooters may enter full squads, but must accept the next vacant squad number. Club Management shall have the right to squad shooters to assist in the organisation of the competition. Re-squadding can occur during any time of the Competition at the absolute discretion of Club Management, Members have no recourse where a re-squadding decision has been made.

#### **1.04 BROKEN TARGETS**

A broken target is one which has a visible piece broken from it, whilst in the air, by the shot from the competitor's gun.

#### **1.05 DUSTED TARGETS**

A "dusted target" is one from which dust is detached by the competitor's shot, but which shows no visible piece broken from it. A dusted target is not a broken target and is a "lost target".

#### **1.06 NO TARGETS**

After "no target" has been called by the Referee under any of the following conditions it thereafter plays no part in the competition and is irrelevant to it.

- (a) No target shall be called when a target is refused for the following reasons:
  - (i) A target is released without the competitor's call and the target has not been fired at.
  - (ii) A time interval occurs before or after the competitor's call unless the target is fired at.
  - (iii) A target does not conform to the definition of a legal target and the target has not been fired at.

*Note: If in the opinion of the Management, an excess of refusals is recorded, the Management has the right to check the shooter, Referee and equipment. If in the opinion of the Referee, legal targets are being refused, the Referee may call "lost target". All refusals must be recorded on the score sheet as "R".*

- (b) "No target" shall be called when:
  - (i) A broken target is released.
  - (ii) In single target shooting, two targets are released at the same time.
  - (iii) When a competitor shoots out of turn or from the wrong lane.

- (iv) Two competitors shoot at the same time, at the same target.
- (v) A malfunction occurs in either barrel caused by the competitors gun or misfire of a cartridge due to no neglect on the competitor's part. In the event of a malfunction of the second barrel, the competitor must fire a live cartridge in the general direction of the target, and is permitted to score with the second barrel only. If the competitor accidentally breaks this target with the first barrel, "no target" shall be called and another thrown; if he again breaks this target with the first barrel, "Lost target" will be scored. If in the opinion of the Referee the first shot was fired before the target was visible, "Lost target" shall be scored.
- (vi) A simultaneous or near simultaneous discharge occurs, ie, from any cause both barrels are discharged together or nearly together. Simultaneous discharges shall be recorded as a malfunction.
- (vii) A different coloured target than being used for the event is thrown and not fired at. Firing at the target shall cause it to be considered a legal target with the result to stand.
- (viii) No target shall be allowed for the first target of any visit to a trap if a safety catch is engaged.
- (c) The following are considered malfunctions of ammunition:
  - (i) Failure to fire when firing pin indentation is clearly visible;
  - (ii) When only the primer fires – or is missing;
  - (iii) When the powder charge has been omitted;
  - (iv) When the powder charge is not ignited;
  - (v) Components of the load remain in the barrel.
  - (vi) All misfires and malfunctions must be marked on the score sheet as "M".

### **1.07 NO TARGETS – DOUBLES**

The referee shall declare "NO TARGET both" and allow another pair under the following conditions.

- (a) When only one target is thrown.
- (b) When either target is thrown broken.
- (c) When there is an allowable malfunction on the first barrel.
- (d) When both targets are broken by one shot.
- (e) In the event of a malfunction on the second barrel, the Referee shall declare "No target on the second barrel". The result of the first shot shall stand and a proof pair thrown to determine the result of the second shot only.
- (f) In the case of a malfunction on the second barrel, should such malfunctions be the fourth or subsequent malfunction, the second target shall be scored lost.

*Note: If the shooter shoots at an illegal first target and the second target is legal, he must also shoot the second target. However, a shooter is not required*

*to shoot at an illegal second target even though he shot at the first target which may have been either legal or an illegal target.*

## **1.08 LOST TARGET**

Lost target shall be called when:

- (a) A competitor fails to break a legal target.
- (b) The competitor fails to shoot because his gun is unloaded, or because the safety was incorrectly set or jarred back, whether from his oversight or not, or because of any other cause chargeable to his oversight or neglect. Should this happen in a double rise event, the first target only should be declared lost and a proof pair shall be thrown to determine the result of the second shot only. A shot shall be fired at each target in the proof pair. A “no target” shall be allowed for the first target of any visit to a trap if a safety catch is engaged.
- (c) The competitor has an apparent malfunction and attempts to open the gun before the Referee examines it. The competitor must not turn around and must keep his gun pointed in the direction of the traphouse until the Referee has given his decision. If a competitor’s gun breaks down and it is necessary to seek a replacement the competitor is allowed five (5) minutes to do so. If this is not possible the competitor may leave the squad and finish the remaining targets of the round at a time decided by the Management. Should a gun malfunction occur during a shoot-off, the competitor has 10 minutes to repair or replace the gun. Failure to comply “Lost target”.
- (d) In single barrel shooting, the competitor loads two cartridges or dummy cartridges into the gun.
- (e) A foot position violation occurs. The competitor’s feet must be behind any line indicating the firing mark assigned to him. He must stand with both feet completely within 1 square metre; this square shall extend 50 centimetres either side of the centre of the shooting lane and shall extend backwards 1 metre from the assigned handicap mark. However, provided his front foot is as close as possible to the firing mark, a shooter with a wide stance will not be penalised if his back foot extends beyond the rear edge of the shooting square.
- (f) The fourth and subsequent malfunction in any one event occurs. However, at the end of each 100 targets in any one event, the malfunctions that have occurred shall be cancelled, and the count shall re-commence from zero.
- (g) A target is dusted.
- (h) A whole target was fired upon and missed.
- (i) An illegal target was fired upon and missed.
- (j) The competitor shoots from other than his approved handicap mark or the common mark for the event.
- (k) If a shooter, when shooting doubles, deliberately shoots at one target twice – both targets will be declared lost.

## **1.09 BAULK**

- (a) Any extraneous occurrence, which in the opinion of the Referee materially interferes with the equity of the competitor after he calls for his target constitutes a baulk.
- (b) The sun shall not be considered as interference. It must be considered as a normal hazard.
- (c) Under no circumstances will a baulk be granted unless claimed by the competitor immediately it occurs, and/or in the opinion of the Referee, a baulk has occurred, he may restore the competitor's target.
- (d) The Referee has power to alter his decision. This must be done before the shooter in question shoots his next target or the shooter leaves the tracks should this be his last target.

## **1.10 ABIDE BY RESULT**

Should there be a faulty cartridge, misfire or malfunction in the first barrel, in any type of event, and the competitor fires the second barrel where possible, the competitor shall abide by the result and shall have no claim to a repeat target for the first barrel.

Where this happens in a point scoring event and the target is broken with the second barrel the decision shall be as follows:

- (a) If there was no detonation of either primer or powder with the first barrel the score shall be "1";
- (b) If there was detonation of either primer or powder with the first barrel the score shall be "2".

In both cases if the target has been missed with the second barrel the score would be lost.

## **TYPES OF SHOOTING**

### **1.11 DOUBLE BARREL**

Double Barrel shall be shot with two barrels permitted and a score on either barrel to be of equal value.

### **1.12 SINGLE BARREL**

For Single Barrel the competitor is permitted to load one cartridge only in the gun. Refer Rule 1.08(d)

### **1.13 POINTS SCORE**

During an event, a hit with the first barrel shall be called and marked 1, a hit with the second barrel shall be called and marked as 2. A miss with both barrels shall be called lost and marked zero. At the completion of the event the 1 shall be valued at 3 and be added to the 2's to give a total for the event.

### **1.14 DOUBLE RISE**

- (a) Double Rise shall be shot squad system and called by the referee, 1-1 or lost – 1 or 1 – lost or lost lost, whichever the case may be, each target to count one point.

- (b) A competitor must shoot at a complete pair of targets on every occasion, each target broken by the competitor's shot shall score one point. Two shots must not be fired at either target.
- (c) For initial grading refer Trap Rule 2.01(p)(i-vi).  
Grades shall be: AA 92% and over; A 84% and under 92%; B 76% and under 84%; C under 76%.
- (d) A shooter may have his grade increased after shooting 100 pair (200 targets), but must shoot three (3) consecutive groups of 100 pair (600 targets) at a lower grade percentage to be down graded.
- (e) No re-grading will apply until the end of the club's programme of that day. Should a shooter shoot at another Club later on that day the new grade will take effect.

### 1.15 DEAUVILLE DOUBLES

- (a) Deauville Doubles shall be shot with four competitors on the tracks at one time, the first pair using lanes 1 and 5 and the second pair using lanes 2 and 4. After shooting first round of 5 pairs, competitors then change lanes, first pair taking lanes 2 and 4 and second pair taking lanes 1 and 5. Shoot offs shall be conducted one team at a time, alternating after each 5 pair using lanes 1 and 5 and then 2 and 4. The competitors may arrange between themselves which lane they will take, and who will call for the release of the targets, which will be released instantly on the competitors acceptable call. Only pairs will count, and as 1 point. Either competitor can help his partner.
- (b) Any faulty cartridge or malfunction in Deauville Doubles does not entitle the competitors to another pair of targets and they must abide by the result.
- (c) The caller shall determine whether the targets be accepted. If in the event of targets being released without any call and the non caller fires, the target shall be called "no target". If no call is made and the caller accepts the targets they must abide by the result.

### 1.16 WALK-UP

- (a) Walk-up events shall be shot double barrel from No. 3 lane in squads. The competitor shall load his gun at the 22 metres mark; when ready in this position he commences to walk at a normal walking pace, holding his gun in such a position that the butt of the gun must be level with his hip and cannot be mounted to the shoulder until the target is released. The Referee shall release the target between the 20 metres and 15 metres marks inclusive, the mark being unknown to the competitor, having previously been determined by an indicator or dice. No. 1 competitor shoots at one target, he then returns to the rear of the squad, each competitor doing the same in turn.

- (b) A loaded gun shall be deemed to be in a position of safety when it is the competitor's turn to shoot and he faces and points the gun in the general direction of the trap house, having the gun in the gun-down position.
- (c) Having fired at the target, or in the event of a no target, the competitor shall open his gun and remove all live shells and fired cases before attempting to turn around and return to the rear of the squad or to recommence his walk.

### **1.17 MIXED TARGETS**

A mixed target event shall be a combination of a series of double barrel, single barrel, points score and double rise targets shot in any order. Shot squad system under rules applicable to the appropriate section with target numbers and shooting marks in accordance with the appropriate championship.

### **1.18 CHAMPION OF CHAMPIONS**

A Champion of Champions event shall be a combination of a series of double barrel, single barrel and points score targets shot in any order. Shot squad system under rules applicable to the appropriate section with target numbers and shooting marks in accordance with the appropriate championship.

### **1.19 TOWER EVENTS**

- (a) Tower events may be shot double barrel, single barrel, points scoring and double rise squad system, competitors stand in a straight line left to right, with centre No. 3 competitor standing in front of the centre of the tower.
- (b) Shooters stand 3 metres apart at the rear of the concrete track, as for down-the-line trap shooting. The track is 1.5 metres from the front to rear and each shooter must stand at the rear of this track until it is his turn to shoot. He then steps forward up to, but not over, the leading edge of the track which then puts him 1.5 metres in front of a vertical line from the centre pivot point of the trap. After shooting, he opens his gun and returns to the rear of the track.
- (c) When Number 5 shooter has shot, he walks to the rear of the tower and around to the No. 1 station.
- (d) The trap shall be 10 metres above the ground, plus or minus 1 metre, mounted on a tower. Targets shall be thrown at standard angles, i.e. 22 degrees either side of the centre line. Tower targets shall be thrown within a minimum of 75 metres and a maximum of 85 metres, measured laterally along the base point of a vertical line from the centre pivot of the trap. The targets shall leave the trap as near to horizontal as practical.
- (e) **For initial grading refer Trap Rule 2.01(p)(i-vi).**  
Grade percentages – AA grade 98% and over. A grade 96% and under 98%. B grade 91% and under 96%. C grade under 91%. Regrading will take place after 200 targets. (follow process of percentage

calculation see Rule 2.01(h)). A shooter may be upgraded after shooting 200 targets. Downgraded after shooting 600 targets (3 brackets of 200) at a lower percentage.

- (f) No re-grading will apply until the end of the club's programme of that day. Should a shooter shoot at another Club later on that day the new grade will take effect.
- (g) Any change to a shooters grade must be entered into the ACTA database by a designated club official. All changes to a shooters grade must be entered into the database within five (5) working days.

## 1.20 CONTINENTAL AND TRAP SETTINGS

Continental events shall be shot double barrel, single barrel and points scoring with the traps set as follows:

- (a) Standard targets shall be thrown 3.0 metres above the level of the centre lane at a point 10 metres from the trap with a tolerance of 15 centimetres above or below.
- (b) Low targets shall be thrown 1.5 metres above the level of the centre lane at a point 10 metres from the trap, with a tolerance of 15 centimetres above or below.
- (c) High targets shall be thrown 4.5 metres above the level of the centre lane at a point 10 metres from the trap, with a tolerance of 15 centimetres above or below.
- (d) Distance – the low target shall be thrown 48 metres (+/- 2 metres) in still air.
- (e) Angles – flight of targets shall be thrown at unknown angles a maximum of 22 degrees right and left of the centre lane.

## 1.21 BALL TRAP AND TRAP SETTINGS

- (a) For initial grading refer Trap Rule 2.01(p)(i-vi).
- (b) Grades shall be: AA 93% and over; A 82% and under 93%; B 70% and under 82%; C under 70%.
- (c) A shooter may have his grade increased after shooting 200 targets, but must shoot three (3) consecutive groups of 200 targets at a lower grade percentage to be down graded.
- (d) No re-grading will apply until the end of the club's programme of that day. Should a shooter shoot at another Club later on that day the new grade will take effect.
- (e) Any change to a shooters grade must be entered into the ACTA database by a designated club official. All changes to a shooters grade must be entered into the database within five (5) working days.
- (f) Cartridges for Ball Trap events shall be restricted to a maximum of 28 grams and to a shot size of no larger than No.6.
- (g) When Ball Trap is being used as an ISSF Elimination, ISSF Rules shall apply, and cartridges are to be of 24 gram maximum.

## Ball Trap Target Elevations

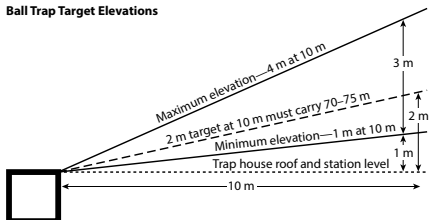

## Ball Trap Layout

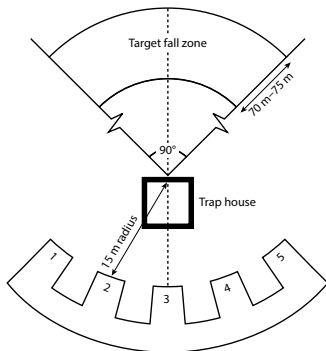

Ball Trap  
 DRAWING NOT TO SCALE

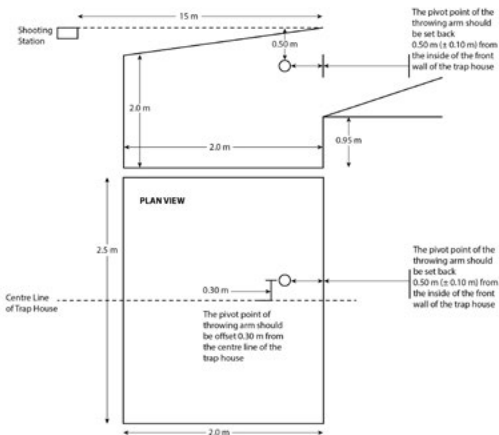



- (h) Target distances and elevations – with a throwing elevation of 2 metres at 10 metres forward of the pit, a properly released target will carry a minimum of 70 metres and a maximum of 75 metres when measured over ground level.
- (i) The height of the targets path above the level of the trap house roof and 10 metres forward of the trap shall be at least 1 metre and shall not exceed 4 metres.
- (j) The targets shall be thrown within an angle bounded by angles not less than 30 degrees nor more than 45 degrees right and left of the imaginary centre line drawn through the centre of the trap house and station three. The horizontal angles will be measured from the front of the trap house.
- (k) All Commonwealth, State, Zone Championships and Club Events must be conducted using ACTA Rules.
- (l) All Commonwealth, State and Zone Championships to be of 50 (minimum), 75 or 100 targets.
- (m) All shoot offs shall be conducted squad system, first miss and out as per **Trap Rule 3.18**.

## **1.22 HANDICAP**

Handicap shooting is to be shot from the competitors official handicap mark.

## **1.23 SWEEPSTAKES DEDUCTION AND CASH DISTRIBUTION**

- (a) Clubs have the option of taking 60% in cash divide events.
- (b) No deduction is permitted by clubs in optional sweepstakes.
- (c) In all sweepstakes, distribution shall be on the basis of 60% (1st), 30% (2nd), 10% (3rd). A competitor scoring the only possible in the event wins only 60% (1st place). All optional sweeps shall be compulsory division as in the above formula. The Management shall clearly indicate on the official score sheet or scoreboard those who have entered for the optional sweep. When running Graded Sweeps/ Cash divide each grade monies to be divided between that grade.
- (d) Sweepstakes at State Carnivals or Championships may be decided by the State concerned. State Associations have the option of conducting either compulsory or optional sweepstakes at State Carnivals.

*Note: In all events, including handicap events, for cash prizes or trophies excluding sweepstakes, trophies and placing's shall be decided by shoot-off. The grading and handicap formula will apply.*

- (e) The inclusion of either compulsory or optional sweepstakes at National Championships and their method of division to be at the discretion of the Executive Committee. Sweepstakes at any competition shall be determined by scores off the gun and shootoffs shall not apply.
- (f) Jackpots must be determined in the manner for when and which they are introduced.

# HANDICAPPING/GRADING

## SECTION 2

### 2.01 COMMON MARK AND HANDICAP SHOOTING

- (a) All appropriate 15 metre scores (competition) shall be recorded for percentage performance classification irrespective of how the event is run, **with the exception of Eye Openers (maximum of 10 targets), Double Rise, and those shot Targets Only.**  
**All targets shot other than 15 metre Double Barrel shall be recorded in the second column designated as Cont and SB. That includes Single Barrel, Continental, and any targets shot as single targets off oscillating traps on any metres shot in competition. Specific Handicap events are not included.**
- (b) (i) A graded event is a competition common mark shooting event in which all the competitors shoot from the same mark and prizes are allocated for various grades of competitor.  
(ii) A graded metreage event is where a shooters grade is used to determine a mark from where all shooters in that grade shall compete, eg AA Grade may shoot from 21 metres; A grade from 19 metres, B grade from 17 metres and C grade from 15 metres. Scores shot in this event shall not be recorded on a shooters ACTA Record Card.
- (c) Shooters shall be graded into four grades by their percentage performance over all standard targets fired upon in 15 metre competition day or night, including shoot-off targets, with broken targets to count in Double Barrel and Points scoring events. Results in events shot from other than 15 metres shall not be included. (Except as in sub-section 2.01(h)).
- (d) Clubs shall have the option of running all Championships other than State or Commonwealth Championships either as graded events or as one class events.
- (e) Grades shall be: AA 97% and over; A 94% and under 97%; B 90% and under 94%; C under 90%.
- Note: Club Managements have the option of shooting D Grade under 80%.*
- (f) Shooters failing to produce their ACTA Record Card at competition shoots shall pay a \$20.00 penalty fee to the club.
- (g) Club Managements have the option of running common mark events OA,AA,A,B,C; AA,A,B,C; First, Second, Third; or by combining. AA & A.or A & B or B & C grades.
- (h) It shall be the responsibility of a designated club official to enter individual event scores and progressively mark the shooter's card with his 15 metre results. After each 200 targets double barrel regrade the shooter if necessary. Double Barrel scores will be transposed for any better scores from the other events column that have a greater percentage value, ie Continental and Single Barrel **and targets shot from a different mark.** If the 200 targets fall during an event or shoot-off, re-grading will not take place until the completion of that event.

All targets to the end of that event and shoot-off targets including those shot from greater metreauges are to be entered into the event column and used in calculation of percentage, except the last target missed in any shoot-off will not be recorded. Once 200 or more targets have been shot at and recorded and after the substitution of any bad scores, the percentage shall be calculated.

- (i) A shooter must shoot a minimum of three (3) consecutive groups of 200 targets, ie 600 targets, at a lower grade percentage to be down graded. Other than in the authority vested in Rule 2.04(g). Once attaining A grade a shooter cannot be regraded to C grade and once attaining AA grade a shooter cannot be regraded to B grade, other than in the authority vested in Rule 2.04(g). A shooter can only be downgraded one grade at a time. All scores after the last grading must be carried forward onto any new ACTA Record Card.
- (j) Shooters awaiting the issue of a ACTA Record Card after registering for the first time shall be allowed to enter in any competition. Scores shot during this period must be kept and entered on his ACTA Record Card when received.
- (k) If a shooter has misplaced or lost his ACTA Record Card he shall be allowed to compete providing he is registered with the ACTA. He shall be allowed to compete in his grade in common mark events and shall be allowed to compete in handicap events from the mark he claims to be his correct handicap mark. Should he win prize money or trophies they must be retained by the club until such time as the shooter presents his ACTA Record Card to the club for marking.
- (l) Should it be found that the shooter has claimed the wrong handicap mark or grade, the Club shall advise the State Association so that the matter may be investigated. If it is determined that the shooter deliberately misled the Club Management regarding his grade and/or his handicap, the shooter will be suspended for three (3) months.
- (m) A shooter must not shoot in a grade higher, or from a handicap greater than his best performance. Once having attained a grade or EARNED handicap he may elect to remain in that higher grade/handicap when due for re-grading/re-handicapping. If he so elects he must remain in that grade for the next three groups of 200 targets, or on his elected EARNED handicap for the next 3 groups of 100 targets. If the shooter so elects his ACTA Record Card must be marked to indicate such. Eg: "prefer A grade", "prefer 22 metres".
- (n) Managements conducting graded common mark events shall provide a minimum of one prize or trophy for each grade.
- (o) All wins shall be recorded with a OW (overall) or GW (grade) beside scores on ACTA Record Cards.
- (p) (i) New shooters without prior competitive shotgun experience will be placed in C grade by the Club for the first 50

- competition targets. At the completion of these first 50 targets they will be given a provisional grade and the targets shot will become part of the first 200 targets for grading purposes.
- (ii) Shooters re-registering after an absence will be placed in the grade and on the handicap mark in which they left the ACTA for the first 50 competition targets. At the completion of these first 50 targets they will be given a provisional grade and the targets shot will become part of the first 200 targets for grading purposes.
  - (iii) Shooters registering with experience in another shotgun code (eg Field & Game) will be placed in the same grade as their current grade in that code for the first 50 competition targets. At the completion of these first 50 targets they will be given a provisional grade and the targets shot will become part of the first 200 targets for grading purposes.
  - (iv) Shooters re-registering after an absence who have subsequently been shooting competition in other shotgun codes will be placed in the same grade as their current grade in that code for the first 50 competition targets. At the completion of these first 50 targets they will be given a provisional grade and the targets shot will become part of the first 200 targets for grading purposes.
  - (v) Shooters when first competing in any ACTA discipline who already have any existing ACTA grade will be placed in the highest grade and handicap achieved at any other ACTA discipline for the first 50 competition targets. At the completion of these first 50 targets they will be given a provisional grade and the targets shot will become part of the first 200 targets for grading purposes.
  - (vi) In each of the above 5 circumstances where an event/events progress past the first 50 targets the shooter will be graded on these event targets, they will be given a provisional grade and the targets shot will become part of the first 200 targets for grading purposes.
- (q) Upgrading of shooters after the initial 200 targets is limited to one grade at a time.
  - (r) No re-grading or re-handicapping will apply until the end of the club's programme of that day. Should a shooter shoot at another Club later on that day the new grade/handicap will take effect.

## **2.02 HANDICAPPING FORMULA**

- (a) Each club must appoint an official to handicap and grade shooters, check to see that all 15 metre double barrel and handicap scores are entered on ACTA Record Cards and to check that handicap and grade changes are recorded on ACTA Record Cards.

- (b) Minimum handicap marks are tied to grades and are as follows: AA Grade – 21 metres, A Grade – 19 metres, B Grade 17 metres and C Grade – 15 metres.
- (c) Backward movement is to apply on high scores according to the following table:

**Earned Metreage Table (High Scores)**

<i>No of Shooters</i>	<i>1st</i>	<i>2nd</i>
20-124	1	
125+	2	1

- (d) Handicapping on percentage will apply after every 100 handicap targets shot, earned metreage will apply as per the following table:

**Earned Metreage Table (Percentage)**

<i>Percentage</i>	<i>Increase</i>
97+	1

- (e) Any score of 50/50 will earn 1 metre provided it does not earn at least that much under the above tables.
- (f) Maximum Handicap 25 metres.

*Note: Penalties by high scores and percentages are not accumulative. However the highest penalty shall apply.*

- (g) The shooters ACTA Record Card is to be ruled off at any handicap change and the 100 targets will then restart.
- (h) There shall be no Group Handicaps.
- (i) All handicap events must be shot to finality – broken targets to count and not points to determine the outcome.
- (j) Maximum load for handicap shooting to be 32g.
- (k) All shooters registering for the first time with the ACTA shall commence on 15 metres.
- (l) Members from other Clay Target Associations will commence from the following handicap marks unless their current handicap is greater that that stated: AA Grade – 21 metres, A Grade – 19 metres, B Grade 17 metres and C Grade – 15 metres.

**2.03 INWARD MOVEMENT**

- (a) A one (1) metre inward movement may apply if a shooter's recorded percentage is less that 90% for 3 consecutive groups of 100 targets.
- (b) When downgrading occurs (for example, A to B) a shooter's handicap will return to the minimum metreage for that grade, providing no earned metreage above the minimum has applied under the handicapping formula.
- (c) A competitor may apply through the State Handicapper for inward movement due to proven physical disability.

## 2.04 ADJUSTMENTS

- (a) Club Management and Secretaries are instructed that at the end of a day the Management must immediately re-handicap each and every shooter who, for any of the reasons prescribed in the ACTA Handicapping Formula, qualified for any movement of his handicap. Such adjustments are to strictly conform with the handicapping formula. No shooter is to be permitted to compete in another event should he refuse to accept his new mark or grade.
- (b) If some clerical error appears on a shooters ACTA Record Card, it is the shooter's responsibility to have the mistake corrected and to shoot off the correct handicap mark.
- (c) Errors and/or amendments may be corrected by the Club Secretary, a member of the Executive Committee of the ACTA, Rule Supervisors or the State or Zone Handicapper.
- (d) Correction to errors and amendments must be ruled out and signed with the correction or amendment clearly visible. Correction fluid or the likes of are not permitted to be used.
- (e) It is the shooters responsibility to ensure that all handicap and common mark scores have been entered correctly, and progressively totalled.
- (f) Any change to a shooters grade or handicap must be entered into the ACTA database by a designated club official. All changes to a shooters grade or handicap must be entered into the database within five (5) working days.
- (g) Club Management, Rule Supervisors, State or Zone Handicappers or a member of the ACTA Executive Committee have the right to re-handicap or re-grade any obviously under-handicapped or over-handicapped, under-graded or over-graded shooter immediately. The Association is to be notified within 14 days with the reason given on a handicap return form.
- (h) In determining a shooters grade or handicap an official may disregard any scores obviously not indicative of the shooters ability at the time of the 100 (handicap) or 200 (grading) target rule off.
- (i) ACTA Record Cards may carry a signed directive by a State or Zone Handicapper, Rules Supervisor or ACTA Executive member.
- (j) Should a shooter's ACTA Record Card carry any signed directive, then no person can vary the directive without the prior consent of the State Handicapper through which the shooter is registered, or a member of the ACTA Executive Committee. Any alteration to the directive must be accompanied by the signature of the respective State Handicapper or ACTA Executive member. It shall be the shooter's responsibility to ensure that any directive is carried over to any new or replacement ACTA Record Card.

# COMPETITION CONDITIONS

## SECTION 3

### **3.01 MACKINTOSH INTERNATIONAL TRAP TEAMS MATCH**

International Trap Teams match shall be shot under the conditions that apply at the time.

Qualifications shall be as follows:

- (a) Each team member shall be an official Australian citizen. In the event of a member being unable to take his place in the team, his place will be filled by another shooter, agreed upon by the Organising Committee.
- (b) The necessary highest scores over the National Double Barrel; National Single Barrel; and the Australian and New Zealand Trap Championship; shall become Australia's International Team. In the event of a tie, to be shot off in the order of qualification, squad system, at full rounds of 5 targets Double Barrel, 5 targets Single Barrel, 5 targets point scoring, for a possible score of 25, from 15 metres.
- (c) Highest Scorer in the Australian team will hold the special International High Gun Cup (donated by the late J M Bauman, Esq of Brisbane) for 12 months (or until the next International match) and will be awarded a special trophy and the International High Gun Sash. In the event of a tie for High Gun, to be shot off squad system points scoring, first miss out.
- (d) Every member of the Australian Team will receive the special "International Badge".
- (e) Women, Junior and Veteran teams of five (5) shooters will be selected under the above conditions.
- (f) Only ACTA official Referees to officiate, Scorer and check Scorer to be provided, score sheets to be signed by Scorers and Referees. The team members to be squadded in the order in which they qualify.

### **3.02 AUSTRALIAN NATIONAL DOUBLE BARREL CHAMPIONSHIP**

To be an event which for the time being shall be shot under conditions as determined by the Executive Committee.

### **3.03 AUSTRALIAN NATIONAL SINGLE BARREL CHAMPIONSHIP**

To be an event which for the time being shall be shot under conditions as determined by the Executive Committee.

### **3.04 AUSTRALIAN NATIONAL DOUBLE RISE CHAMPIONSHIP**

To be an event which for the time being shall be shot under conditions as determined by the Executive Committee.

### **3.05 AUSTRALIAN NATIONAL DEAUVILLE DOUBLES CHAMPIONSHIP**

To be an event which for the time being shall be shot under conditions as determined by the Executive Committee.

### **3.06 AUSTRALIA-NEW ZEALAND TRAP CHAMPIONSHIP**

To be an event which for the time being shall be shot under conditions as determined by the Executive Committee.

### **3.07 CHAMPION OF CHAMPIONS CUP**

To be an event which for the time being shall be shot under conditions as determined by the Executive Committee.

### **3.08 GRAND AUSTRALIAN HANDICAP**

To be an event which for the time being shall be shot under conditions as determined by the Executive Committee.

### **3.09 ENTRANCE FEES**

Entrance fees and trophies for all National Championships to be determined each year by the full Executive Committee.

### **3.10 NATIONAL OVERALL HIGH GUN TROPHIES**

#### **(a) RON PORTER REMEMBRANCE TROPHY**

Shall be determined from the highest overall scores in the six major trap events comprising Grand Australian Handicap, National Double Barrel, Single Barrel, ANZ Trap (PS), Champion of Champions and Double Rise. In the event of ties, to be shot-off in the sequence of the program, five of each type of trap target on the high gun program.

#### **(b) J NEWTON THOMAS OVERALL HIGH GUN TROPHY**

Shall be determined from the highest overall Scorers in the six major events of Grand Australian Handicap, National Double Barrel, Single Barrel, ANZ Trap (PS), Champion of Champions, Double Rise. In the event of ties, to be shot-off in the sequence of the program, five of each type of trap target on the high gun program.

### **3.11 AUSTRALIA-NEW ZEALAND TRAP TEAMS MATCH (Glenn Cup)**

#### **(a) Teams to consist of five shooters. Both teams shoot at 50 targets per shooter, Double Barrel from 15 metres; to be recorded points score (used only in the case of a tied score). Should scores still be tied a further 5 targets per shooter per team scored points score will be shot, continuing until a winner is established. Each competitor to shoot from five lanes, squad system. Cartridges shall be the prescribed maximum 28-gram shot load as for all Championship series.**

#### **(b) Team Selection – whether conducted in Australia or New Zealand shall be the five top scorers from Single Barrel, Double Barrel,**



Australia/New Zealand (Point Score) and Mackintosh Team event will comprise the Australian team.

- (c) The match is to be hosted alternatively by arrangement, in Australia during the odd numbered years.

### 3.12 COMMONWEALTH EVENTS (Day or Night)

- (a) The Double Barrel Championship shall be shot as a graded event at a minimum of 50 targets from 18 metres.
- (b) The Single Barrel Championship shall be shot as a graded event at a minimum of 50 targets from 18 metres.
- (c) The Points Score Championship shall be shot as a graded event at a minimum of 50 targets from 18 metres.
- (d) The Mixed Target Championship shall be shot as a graded event at 10 targets Double Barrel, 10 targets Single Barrel, 10 targets Points Score and 10 pairs Double Rise off 18 metres – total 70 points.
- (e) The Champion of Champions shall be shot as a 75 target graded event comprising 25 targets Double Barrel, 25 targets Single Barrel and 25 targets Points Score from 18 metres.
- (f) The Handicap shall be shot at a minimum of 50 targets from the shooter's official ACTA handicap mark.
- (g) The Walk-Up Championship shall be shot as a graded event at 25 targets.
- (h) The Double Rise Championship shall be shot as a graded event at 25 pairs of targets from 18 metres.
- (i) The Deauville Doubles Championship shall be shot at 20 pairs of targets from 24 metres. Conditions: The Management shall provide four trophies – two for first and two for second.
- (j) The Tower Championships shall be shot as a graded event at 40 targets. Double Rise to be shot at 20 pairs of targets.
- (k) The Continental Championships shall be shot as a graded event at a minimum of 50 targets from 18 metres.
- (l) The Ball Trap Championship shall be shot as a graded event of 50 targets (minimum), 75 targets or 100 targets (maximum) from 15 metres.

### 3.13 STATE EVENTS (Day or Night)

- (a) The Double Barrel Championship shall be shot as a graded event at a minimum of 50 targets from 15 metres.
- (b) The Single Barrel Championship shall be shot as a graded event at a minimum of 50 targets from 15 metres.
- (c) The Points Score Championship shall be shot as a graded event at a minimum of 50 targets from 15 metres.
- (d) The Champion of Champions shall be shot as a 75 target graded event, comprising 25 targets Double Barrel, 25 targets Single Barrel, 25 targets Points Score from 18 metres.
- (e) The Mixed Target Championship shall be shot as a graded event at

- 10 targets Double Barrel, 10 targets Single Barrel, 10 targets Points Score and 5 pairs Double Rise from 15 metres – total 60 points.
- (f) The Handicap shall be shot at a minimum of 50 targets from the shooter's official ACTA handicap mark.
  - (g) The Walk-Up Championship shall be shot as a graded event at 20 targets.
  - (h) The Double Rise Championship shall be shot as a graded event at 25 pairs of targets from 15 metres.
  - (i) The Deauville Doubles Championship shall be shot at 20 pairs of targets from 22 metres. Conditions: The Management shall provide four trophies – two for 1st and two for 2nd.
  - (j) The Tower Championship shall be shot as a 25 targets graded event. Double Rise to be shot as a graded event 15 pairs of targets.
  - (k) The Continental Championship shall be shot at a minimum of 50 targets as a graded event from 15 metres.
  - (l) The Ball Trap Championship shall be shot at 50 targets (minimum), 75 targets or 100 (maximum) as a graded event.

### 3.14 ZONE EVENTS (Day or Night)

- (a) The Double Barrel Championship shall be shot as a graded event 25 or 50 targets from 15 metres.
- (b) The Single Barrel Championship shall be shot as a graded event 25 or 50 targets from 15 metres.
- (c) The Points Score shall be shot as a graded event 25 or 50 targets from 15 metres.
- (d) The Mixed Target Championship shall be shot as a graded event 10 Double Barrel, 10 Single Barrel, 10 Points Score and 5 pairs Double Rise targets – total 60 points from 15 metres.
- (e) The Champion of Champions shall be shot as a graded event 75 targets, comprising 25 targets Double Barrel, 25 targets Single Barrel, and 25 targets Points Score from 18 metres.
- (f) The Handicap shall be shot 25 or 50 targets from the shooters official ACTA handicap mark.
- (g) The Walk-Up Championship shall be shot as a graded event at 20 targets.
- (h) The Double Rise Championship shall be shot as a graded event 15 pairs of targets from 15 metres.
- (i) The Deauville Doubles Championship shall be shot 20 pairs of targets from 20 metres.
- (j) The Tower Championship shall be shot as a graded event 25 targets.
- (k) The Continental Championship shall be shot as a graded event 25 or 50 targets from 15 metres.
- (l) The Ball Trap Championship shall be shot as a graded event at 50 targets (minimum), 75 targets or 100 targets (maximum).

### **3.15 DISTRICT EVENTS (Day or Night)**

- (a) The Double Barrel Championship shall be shot at 25 targets from 15 metres.
- (b) The Single Barrel Championship shall be shot at 25 targets from 15 metres.
- (c) The Points Score Championship shall be shot at 25 targets from 15 metres.
- (d) The Mixed Target Championship shall be shot at 5 Double Barrel, 5 Single Barrel, 5 Points Score and 5 pairs Double Rise – total 35 points from 15 metres.
- (e) The Champion of Champions shall be shot as a 75 target event, comprising 25 targets Double Barrel, 25 targets Single Barrel, and 25 Points Score from 18 metres.
- (f) The Handicap shall be shot at 25 targets from the shooters official ACTA handicap mark.
- (g) The Walk-Up Championship shall be shot at 20 targets.
- (h) The Double Rise Championship shall be shot at 10 pairs of targets from 15 metres.
- (i) The Deauville Doubles Championship shall be shot at 20 pairs of targets from 20 metres.
- (j) The Tower Championship shall be shot at 25 targets.
- (k) The Continental Championship shall be shot at 25 targets from 15 metres.

### **3.16 SASHES/DONATED TROPHIES**

- (a) Sash colours for clubs to be any colour other than those designated for National, Commonwealth – both royal blue, State – red or alternatively Official State colours.
- (b) In all Championships the Management shall provide a sash or badge for the overall winner.
- (c) In all National, State and Zone Handicap events the Management shall provide a sash or badge for the overall winner.
- (d) Any person/s or organisations may donate a trophy or trophies for competition but must comply with ACTA regulations.

### **3.17 INTERSTATE POSTAL TEAM MATCHES – TRAP**

- (a) Team 15 members, 10 highest scores to count. 50 targets per member from 15 metres, Double Barrel points scoring, shot squad system in two visits of 25 targets. In the event of a tie for High Gun to be shot off squad system, points scoring first miss out. Standard load shells 28 grams shot No. 6 size or smaller only.
- (b) Women, Juniors & Veterans to comprise 6 shooters to shoot at 25 targets, Double Barrel points scoring from 15 metres, shot squad system with 5 scores to count.
- (c) Qualifications: each team member shall have registered in the State which he represents and may only represent one State in any one

- calendar year. In the event of a tie, to be shot off in the order of qualification, squad system at full rounds of 5 targets double barrel, 5 targets single barrel, 5 targets points score.
- (d) State Associations shall select their team on the results of an elimination shoot or series.
  - (e) Shooters who qualify to represent more than one team, eg open and juniors, may compete in each match at the discretion of their State Associations. Scores may not be transposed.
  - (f) An appropriate High Gun trophy shall be provided and a souvenir badge shall be given to each of the 15 State Team members. The program and venue of the Interstate Teams' Match shall be advertised in the ACTA Shooting News prior to the event.
  - (g) Only official ACTA Referees to officiate, Scorer and check Scorer to be provided. Score sheets to be signed by Scorers and Referees.
  - (h) No other major shoot is permitted in the particular State on the day or days when elimination and State Teams Shoot is held.
  - (i) Results of the competition, which must be completed by December 31, must not be publicised until all teams have contested. These result, including the score sheets signed by both the Referee and Principal Scorer, must be sealed and lodged with the ACTA Executive Director by December 31. A check Scorer should be used at each set of tracks. Final details of the Interstate Teams' Matches to be published in the first available ACTA Shooting News.
  - (j) Should a tie occur between competing teams, then the score sheets shall be checked, points scoring, with a countback for the 10 members of each team (or the 5 women, 5 juniors & 5 veterans) to break the tie.
  - (k) In the event of the competition being suspended, for whatever reason, all targets shot shall count and competition completed as soon as possible, commencing from where the competition was suspended. (Refer Rule 4.19)

### **3.18 EVENT TIES – TRAP**

- (a) All double barrel, single barrel points score and handicap events shall be shot off squad system, first miss out. When more than one squad participates in a shoot off, they may commence shooting on different traps providing management deems that the situation is equitable, otherwise all competitors will commence on the same trap. Competitors shall close up when commencing at each trap or at the recommencement of shooting after a break for ammunition where the shoot-off is being solely conducted on one trap. Shoot-off competitors shall carry enough shells for a complete run over multiple traps or for at least 25 targets where the shoot-off is being conducted over one trap. Failure to comply "lost target".
- (b) Competitors shall be re-squadded at the commencement of each run over a line of traps or immediately there is only one survivor

of a run over a particular trap (ie, no competitor shall be required to commence a run over a trap on his own unless he is the last competitor in the shoot-off).

- (c) Deauville Doubles: First miss & out shot as per Rule 1.15.
- (d) Double Rise: In the event of a tie to be shot off squad system, 5 pairs, total 10 points until finality.
- (e) Walk Up: To be shot from centre lane, best of five targets until finality.
- (f) Mixed Targets: To be shot in any order from No. 3 lane, 2 double barrel, 2 single barrel, 2 points score, 1 pair double rise. Total 12 points until finality.
- (g) Tower: Double barrel, single barrel and points scoring shoot-offs to be shot squad system, first miss out.
- (h) Champion of Champions: To be shot 5 targets double barrel, 5 targets single barrel, 5 targets points score, squad system, across the tracks.
- (i) In all shoot-offs, competitors shall shoot in the order in which they qualified.
- (j) At the discretion of Club Management, shoot-offs may be conducted in conjunction with the following event providing it is the same type of event.
- (k) At the completion of qualification in a Double Barrel event Club Management have the right to decide on the method for finalisation of the event.

### **3.19 HIGH GUN – TRAP**

- (a) High Gun shoot-offs at National Championships shall comprise of 5 target handicap, 5 target double barrel (15 metres), 5 target single barrel (15 metres), 5 target points score (15 metres), 5 target double barrel (18 metres), 5 target single barrel (18 metres), 5 target points score (18 metres), 5 pair double rise (15 metres) continuing until such time as the winner is determined.
- (b) The High Gun for a shoot shall be over the advertised program comprising a minimum of two events, or such as the club, at its discretion has advertised. In the event of a tie for High Gun, where such program included varied types of events, the shoot-offs shall consist of a minimum of two of each type of targets on the High Gun program, all to be shot from the centre lane with the highest over the full round or rounds to be the winner. Points events must count as points to determine the High Gun. High gun shoot-off procedures can be determined by Club Management.
- (c) **At National and State Events, Section High Guns will be awarded to the highest scoring shooter in that section.**
- (d) When ISSF Disciplines are involved, any two targets shall be shot from the centre station.

- (e) When graded High Guns are awarded over a program, each competitor will remain in the grade first nominated in, even if his grade or handicap changes during the program.
- (f) When multi-disciplines high guns are shot, they will be that of the discipline of the highest grade. For example, B grade Trap, AA grade Skeet, C grade ISSF Trap – High Gun grade AA as in Skeet.

### **3.20 STATE SHOULDER TO SHOULDER TEAM MATCHES – TRAP**

- (a) Teams shall comprise – Open 5 persons, Ladies 3, Juniors 3 and Veterans 3.
- (b) All teams will shoot at 25 targets from 15 metres, shot squad system. Scoring will be Double Barrel with Points Scoring used to break Double Barrel ties.
- (c) Qualifications: each team member shall have registered in the State which he represents and may only represent one State in any one calendar year.
- (d) State Associations shall select their team on the results of an elimination shoot or series (State Carnivals).
- (e) Shooters who qualify to represent more than one team, eg open and juniors, will compete in only one team.

# ADMINISTRATION

## SECTION 4

### 4.01 TRAP LAYOUT

- (a) A standard trap layout shall consist of five firing points arranged on the arc of a circle of radius 16 metres and whose centre is the trap, firing points to be 3 metres apart, numbered 1-5 from left to right when viewed from the firing points and facing the trap, with No. 3 firing point directly behind the trap.
- (b) A horizontal line joining No. 3 firing point and the trap and prolonged indefinitely will be known as the "Centre Line".

### 4.02 FIRING POINTS FOR HANDICAPS

- (a) These firing points are situated at intervals of 1 metre from 15 to 25 metres behind the trap on lines from the trap extended through the firing points for standard trap layout. These firing points may be

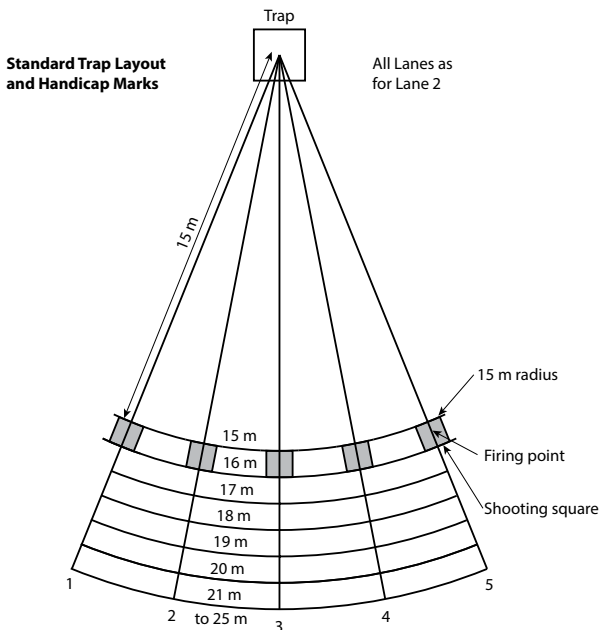

### Trap Layout Safety Template

March 2000 Scale 1:1414

Enlarge A4–A3 for a Scale of 1:1000

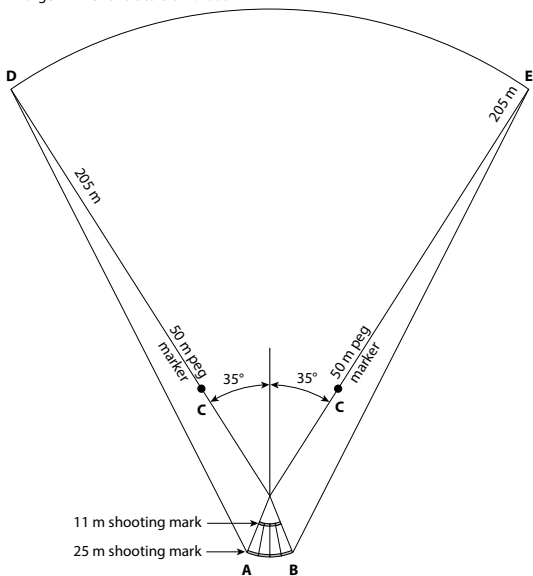

- A** — Shooter No. 1 25 m mark
- B** — Shooter No. 5 25 m mark
- C** — 50 m target angle and distance peg

**D & E** — 205 m from shooters 1 and 5 on an 11 m mark. On a line extended through the 50 m angle and distance peg on the opposite side of the centre line

Safety template covers an area bounded by the lines between points **A–D** and **B–E** and the arcs **D–E** and **A–B**

referred to as “Handicap Marks” and each line of firing points shall be known as a shooting lane.

- (b) The 15 metre mark is to be measured from the top centre pivot point of the trap.
- (c) This collection of firing points and shooting lanes, forming a fan shaped pattern, shall be known as the “Shooting Tracks” and on each lane distances should be clearly marked to signify the forward limit of each firing point.
- (d) Standard Trap layout and handicap marks are shown in figure 4.1.



#### 4.03 TRAP HOUSES

- (a) Trap houses shall be used to give full protection to the trappers. These houses shall be 1 metre high in front, tapering or sloping to 85 centimetres at the back, and shall be 2 metres from back to front, 2.5 metres wide. A tolerance of 10 centimetres either way is permissible on these dimensions. All height measurements shall be taken from the level of the centre lane. The trap shall be mounted in a manner which will bring the top centre pivot point of the throwing arm 35 centimetres above the level of the centre lane and 1.5 metres from inside back of traphouse and 30 centimetres left of centre. A tolerance of 5 centimetres either side of this dimension is permissible.
- (b) If when installing an automatic trap, Rule 4.04(a) cannot be adhered to, then the target is to be thrown at an angle of 15 degrees from the centre line, with the height stick adjusted to make this possible. (See diagrams)
- (c) Trap Layout Safety Template
- (d) Trap houses shall be used to give full protection to the trappers. All traphouses constructed after 1st January 2005 shall be 0.8 metres high in the front, tapering or sloping to 0.65 metres at the back and shall be 2 metres from back to front and 2.5 metres wide. A tolerance of 10 centimetres either way is permissible on these dimensions. All height measurements shall be taken from the level of the centre lane. The trap shall be mounted in a manner which will bring the top centre pivot point of the throwing arm 25 centimetres above the level of the centre lane and 0.5 metres from the front of the traphouse and 30 centimetres left of centre. A tolerance of 10 centimetres either side of these dimensions is permissible.

#### 4.04 LEGAL TARGETS – SINGLES

- (a) Targets, to be legal, shall be thrown 48 metres (+/- 2 metres) in still air with a flight of 3 metres (+/- 0.25 metres) above the centre lane at a point 10 metres from the trap.
- (b) As an aid in determining the legality of targets, where possible three pegs at least 1 metre high are to be placed on the arc of a circle (known at the "Distance Circle") of radius 48 metres and whose centre is the trap; one on the centre line – "The Central Peg"

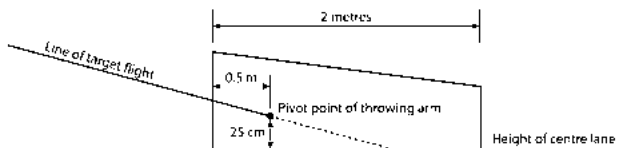

– and one other each 22 degrees to the right and left of centre line respectively. These two pegs will be known as the “Lateral Limit Pegs”. Concrete blocks and measuring sticks for measuring target height are to be standard equipment at all clubs.

- (c) Use of Radar/Speed Guns – Where the distance of targets cannot be measured due to geographical features that limit the provision of “Lateral Limit Pegs”, and or as an aid to setting uniform target speeds, a Radar/Speed Gun may be used in conjunction with height pegs to establish target distance.

Two types of Radar/Speed Gun – High Power and Low Power:

- (i) High Power – (Kustompro, Stalker, Vitronics, LTI & similar), measure target speed leaving the edge of the trap, used from the 15 metre mark with the trap set on straight away,
- (ii) Low Power – (Bushnell, Sport Radar & similar), used to measure target speed leaving from the edge of the trap used from immediately behind the trap house with the trap set on straight away.

Target Speeds (in still air) Single Target – minimum 67.5 km/hr, maximum 69.25 km/hr.

#### 4.05 LEGAL TARGETS – DOUBLES

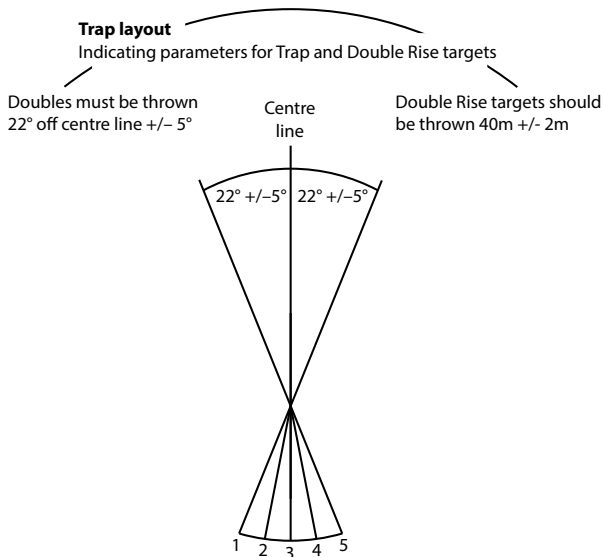

Each pair of double rise targets shall be thrown as left and right quartering respectively at right and left of the centerline. Targets to be legal, shall be thrown 40 metres (+/- 2 metres) in still air with a flight of 3 metres (+/- 0.25 metres), above the centre lane at a point 10 metres from the trap.

Target angles will be 22 degrees right and left of centreline +/- 5 degrees.

For target set-up using Radar Gun refer Rule 4.04(c)

Target speeds (in still air) Double Rise – Right hand target off single trap – 62.75 km/hr, maximum 64.5 km/hr. Both targets off twin traps 62.75 km/hr, maximum 64.5 km/hr.

#### **4.06 TARGETS**

Targets shall measure not more than 11 centimetres in diameter not more than 2.85 centimetres in height nor more than 110 grams in weight.

#### **4.07 TRAPS**

In all open events any trap which throws a legal target may be used, provided the target is released from a position in the field by mechanical or electrical device (NOT released from within the traphouse).

Automatic traps are strongly recommended for all disciplines.

#### **4.08 FIREARMS**

- (a) The term “Magazine gun” applies alike to self loading or pump action firearms and other firearms not directly dependent on hand loading and are permissible for clay target shooting.
- (b) Release trigger firearms shall only be used on registered ACTA grounds, subject to the following conditions:
  - (i) ACTA shooters wishing to use a release trigger shall make application to a Rules Supervisor for approval. The Rules Supervisor shall, by whatever means he determines, have the applicant examined on his understanding of the use of a release trigger device. Where a Rule Supervisor has satisfied himself that the applicant understands the use of a release trigger device the shooter shall be included on the master register of release trigger users and his ACTA Record Card shall be marked accordingly by the ACTA.
  - (ii) No ACTA shooter other than those authorised by this rule shall use a release trigger firearm.
  - (iii) All release trigger firearms used by ACTA shooters and overseas visitors shall be clearly labelled in a conspicuous place near the breech.
  - (iv) Release trigger firearms shall not be left in gun racks or in positions where they can be handled but shall be constantly under the control and supervision of the user.
- (c) No firearm which has a gauge larger than 12 gauge is permitted nor shall any barrel(s) length be shorter than 63 centimetres overall.

- (d) The use and carriage of military style shotguns is prohibited on ACTA grounds at all times. Military style firearms are those which could include: forward pistol grips, collapsible or folding stocks, detachable magazines, barrel shrouds or flash suppressors. On application to a Rules Supervisor an exception can be made to a standard competition gun fitted with a pistol grip for a person with a handicap requiring such a grip.
- (e) A maximum of two cartridges are allowed in any gun at any one time.
- (f) No sighting devices other than conventional sights shall be permitted. Any device fitted to a gun that has magnifying, light emitting, forward lead displacement properties, or that give visual enhancement of the target are prohibited.

#### **4.09 CARTRIDGES**

- (a) For all 12 gauge events (Commonwealth, State, Zone, District, Club) other than Handicap, the load is limited to 28 gram struck measure or equivalent shot size not larger than no. 6. Reloads are permitted in all events including National Championships.
- (b) For handicap, load is limited to 32 grams struck measure or equivalent, shot size not larger than no. 6.

#### **4.10 COMPETITOR AND COMPETITION**

Wheresoever the word "Competition" may be used in the following rules, it is to be understood to refer to each particular event, and must at all times be construed by the Management in whose charge the carrying out of such "Competition" has been entrusted.

- (a) Open Shoots, that is Commonwealth, State, Zone and District Championships and open competitions must have the approval of the State Association before being advertised or conducted. (This rule applies to the actual event and the proposed date of holding.)
- (b) Clubs allocated Commonwealth Championships and Interstate Teams' Matches must advertise the event in ACTA Shooting News prior to the actual shooting date.
- (c) Clubs allocated State Championships must advertise these events in the ACTA Shooting News.
- (d) A competitor is one who has nominated for a particular event and whose name appears on the official score sheets or scoreboard. A competitor can participate only once in each event. Each competitor shall carry and present his current ACTA Record Card at all shoots.
- (e) Every competitor entering competitions agrees to accept all official decisions, and to abide by the rules controlling the competition.
- (f) All competitors must be registered through an affiliated club with the ACTA before taking part in competition. Non ACTA shooters are not permitted to compete at any time.
- (g) Competitors must at all times use their correct names when entering a competition. Shooting nom-de-plumes are not permitted.

- (h) Any competitor who commences an event and withdraws, or is disqualified from the competition, forfeits the right to resume and to any refund from the event.
- (i) Non resident shooters shall be granted reciprocal rights if able to produce evidence of their membership of a similar international clay target shooting organisation. Their grade shall be determined by their current percentage.

#### **4.11 AGE ELIGIBILITY FOR COMPETITION**

- (a) Junior category to be under the age of 18 years on the date of competition.
- (b) Sub-Junior category be under the age of 15 years on the date of competition.  
(Minimum participation age shall be subject to State Law.)
- (c) Veteran category to be a minimum of 65 years of age on the date of competition.

#### **4.12 CATCHING UP**

- (a) No shooter may be allowed to enter an event after the commencement of the second round of that event.
- (b) Any shooter who, after completing his event, shoots for targets only is deemed ineligible for any recognition in the event or High Gun program.
- (c) Practice is permissible on all occasions that an official practice trap is operating.

#### **4.13 TARGETS ONLY**

Shooting for targets only, is a term which shall be held to define the status of a competitor in any given event, or events, or in an entire tournament program, and shall signify that a competitor is “shooting for targets only” and has no interest in any trophy or trophies, nor any interest in money or monies in any specific event or events or in the entire program. The competitor’s name shall be placed on the squad board, signifying that he is shooting for targets only. “Shooting for targets only” shall be allowed in any event at the discretion of the Club Management.

#### **4.14 CHALLENGE**

- (a) At all major competitions a jury shall be appointed. Any appointed jury shall have the authority to supervise the setting of traps and their decision shall be binding.
- (b) A competitor may challenge the load of any other competitor. On receipt of a written challenge, with \$20 forfeit, the Management shall obtain a cartridge from the challengee, and if after examination the Management finds the challengee has violated requirements he may be disqualified providing the offence was wilfully committed. If the challengee is wholly innocent, the forfeit shall be paid to him,

otherwise it shall be returned to the challenger. The Management of any club, or of any tournament has the power to examine any competitor's cartridges at their discretion, without involving themselves in any penalty.

- (c) A competitor may appeal against the decision of a Referee in regard to interpretation and application of these rules. The competitor shall advise the Referee before he leaves the shooting track that he intends to appeal, and immediately upon completing his run over the traps the competitor shall lodge a written appeal and \$20 forfeit with the Management.

#### **4.15 MANAGEMENT**

- (a) The Management of any club holding a tournament or competition under these rules, has the authority to reject any entry in the said tournament or competition with good reason, and to disqualify any competitor who acts in an unsportsmanlike or disorderly manner, or who violates safety requirements.
- (b) The Association shall keep a register of shooters. No person may enter or compete at any Association competition or event conducted by a member or members or sub-committee appointed for that purpose, unless such person is registered with the Association as a registered shooter and is not in arrears with his registration fees. The Association shall have the right of refusing to register any person as a registered shooter without giving any reason for such refusal. The registration fee payable by a registered shooter shall be such as the Executive Committee shall from time to time prescribe. The Association shall have the right to de-register any registered shooter for conduct which the Executive Committee decides is unsportsmanlike, or for any breach of the Rules or by-laws of the Association, or for failing to observe the decisions of the Association.
- (c) Should darkness, bad weather, or other cause interfere with the competition, the Management shall have the right to decide when and how the competition shall be completed. If postponed the event must be completed within one calendar month. Any competitor who defaults in respect of such postponed competition forfeits all his rights and standing therein.
- (d) All clay targets broken or otherwise shall remain the property of the club.
- (e) ACTA Record Cards must be produced upon request by either Club Management, Zone or State Handicappers, Rules Supervisors, State Associations and National Executive members of the ACTA. In the event of an investigation by any listed parties they have the right to retain the ACTA Record Card for the period of time necessary to undertake the investigation. Upon the request of the National or a State Handicapper a member must provide

their Record Card to that authority within 14 days. Failure to provide will result in the member being classified as AA grade and a Record Card issued to their Club with advice that their grade has been changed on the National data base. This grade is not to be changed until the Authority requesting the Record Card has received and reviewed it.

#### **4.16 JURY**

- (a) The Management shall appoint a jury of three. The jury shall be appointed from (in order) members of the Executive Rules Sub Committee, Executive Committee, Rules Supervisors, Referee Examiners, Qualified Referees on the grounds, to examine the matter.
- (b) Should the competitor's appeal be upheld, his deposit shall be returned and the correct ruling shall be applied to the target appealed against. Should the appeal be disallowed the deposit shall be forfeited and paid to the club concerned. There shall be no appeal against a Referee's decision in regard to whether a target is legal or whether it has been missed.

#### **4.17 REFEREE**

- (a) To become a registered Referee, a candidate shall approach his Club Secretary and President, who (when they consider that the candidate has achieved a satisfactory standard) shall recommend in writing to the nearest registered Referee Examiner on the prescribed form that the candidate be given a practical and oral examination. When the candidate has passed this examination to the Examiner's entire satisfaction, the Examiner will then submit his recommendation plus the form to the ACTA Executive Director, who will issue a Referee badge to the candidate. Any candidate who has failed and wishes to be re-examined must be re-examined by the same Examiner.
- (b) The Rules Supervisors will keep a record of all Referees in their State.
- (c) Club Management complaints regarding a Referee or Referee Examiner shall be referred to the nearest Rules Supervisor within the State for investigation. The Rules Supervisor has the power to suspend the person concerned until the State Association Meeting. If justified, the State Association has the power to further suspend and recall the Referee or Referee Examiner's badge and shall advise the ACTA Executive Director of the action taken.
- (d) Referees shall be appointed for a period of five (5) years and are eligible for re-examination. Any Referee or Referee Examiner who fails to register in any year will have his name automatically removed from the Association Referee and Referee Examiner list.
- (e) The Referee's decision in all cases coming under his jurisdiction as set forth in the rules shall be final. Referees are requested to wear their official badge at all shoots.

#### **4.18 DUTIES OF REFEREES**

- (a) The Referee, besides attending to special duties set forth in these rules, shall adjudicate the competition, he shall distinctly and loudly announce the result of each shot by calling out “one” when the target is broken, except Points Scoring where he shall call “one” or “two”. He shall decide all other issues which arise in relation to the direct competition.
- (b) A check Referee may be employed for Deauville Doubles and Double Rise competition, with the Chief Referee to give the decision.
- (c) If the Referee is negligent, or inefficient, impairing thereby the equity of the competition, the Management may forthwith remove him. This rule applies also to Scorers, target release operators, trappers and any other of the staff.
- (d) The Referee is empowered to challenge the ammunition used by any competitor.
- (e) The Referee has power to alter his decision. If altering his decision on “lost target” or “balk” etc, during the competition, this must be done before the shooter in question shoots his next target or the shooter leaves the tracks should this be his last target.
- (f) **The officiating Referee MUST have a trap checked and if required adjusted immediately, if in the opinion of the majority of the competitors in the squad, it is not throwing legal targets.** Immediately following such alteration, a target must be thrown and the competition continued. Unauthorised shooters are not to interfere with or attempt to interfere with the setting of the trap. Violation of this rule may be grounds for disqualification from the event.
- (g) He must have complete knowledge of the rules of the ACTA and shall adjudicate the competition at all times as set by the Management.
- (h) It is his responsibility to announce the conditions as set out in the rules for each event before the competition commences, also to deploy shooters to their correct firing lanes.
- (i) As shooting proceeds he must observe that shooters are commencing on their correct mark, not shooting out of turn, are handling their guns with safety, and using the correct cartridge.
- (j) The Referee must be efficient and alert at all times and it is most important that he should gain the confidence and respect of each and every competitor.

#### **4.19 DUTIES OF A SHOOT MARSHAL**

- (a) He must observe all the duties of the official Referee.
- (b) He must be present at all shoot-offs.
- (c) He must see that all traps are checked for correct height and angles during competition and prior to shoot-off.
- (d) The Shoot Marshal shall be in charge of all operations and personnel relating to the shoot, and shall be responsible only to



the Management. A Shoot Marshall cannot over-rule the Referee's decision (See Rule 4.17)

- (e) He must instruct and roster the duties of all personnel prior to the commencement of each day's shooting.

#### **4.20 DUTIES OF REFEREE EXAMINER**

- (a) To examine applicants for Referee in trap who have been recommended as required in the ACTA Shooting Rules.
- (b) To assess the applicant's temperament, fairness, his ability to control a situation and his personal behaviour on the shooting tracks as a shooter before considering an examination.
- (c) To observe the actions of existing Referees on the shooting ground and to discuss any problems or make any recommendations considered appropriate.
- (d) To make himself available when convenient to attend rules discussions when required by clubs.

#### **4.21 DUTIES OF RULES SUPERVISOR**

- (a) A maximum of two suitable qualified persons appointed by the relevant State Association until such time as they may elect to resign or alternatively are replaced by their State Association. Rules Supervisors must be selected from experienced Referee Examiners who have held that position for a minimum of three years.
- (b) To examine applicants theoretically and practically for the position of ACTA Trap, Skeet and Sporting Referee Examiner and to advise the ACTA when the applicant is successful. Also to examine, or arrange for applicants to be theoretically and practically tested for the position of ACTA ISSF Referee Examiner and to advise the ACTA when the applicant is successful. Maximum of one ISSF Referee Examiner per State to be appointed.
- (c) Prior to the applicant attaining the status of Referee Examiner, an applicant must have completed a three year term as an official ACTA Referee.
- (d) To observe the actions of existing Referee Examiners and Referees and to discuss any problems concerning their duties.
- (e) To investigate the written complaint of any Club Management or Referee Examiner concerning the ability of existing Referees and to report to the appropriate State Association when action is considered necessary, with full facts so that the State Association concerned may recommend the action to be taken.
- (f) To investigate the written complaint of any Club Management concerning the ability of any Referee Examiner and to report the facts to the appropriate State Association concerned, so that the State Association concerned may recommend the action to be taken.
- (g) To arrange or require the re-examination of any Referee Examiner or Referee when considered necessary.

- (h) A Rules Supervisor should not generally carry out Referee examinations but may do so if requested or if there is no Referee Examiner in the area.
- (i) To make themselves available when convenient to attend rules discussions when requested by clubs. To make themselves available to attend the Bi-Annual Rules Supervisors meeting.
- (j) To keep an up to date list of current Referees within their State and to arrange for their re-examination prior to the expiry date.
- (k) To investigate any serious breaches of these Shooting Rules when requested in writing by Club Management or individual members, and to provide a written report of the findings (if considered necessary) to the relevant State Association for action.
- (l) To adjudicate on the interpretation of these Shooting Rules within their State when requested by Club Management or individual members.
- (m) To have applicants examined (by any means the Rules Supervisor determines) on their understanding and safe use of a Release Trigger device before the applicant can use a Release Trigger device at any ACTA affiliated Shooting Ground.

#### **4.22 REFEREE AND SCORER**

- (a) The Scorer shall keep an accurate record of each shot, according to the Referee's call. He shall mark the figure 1, 2 or 0 relative to the Referees call. If the Scorer is incompetent at scoring, the Referee has the right to change the Scorer before commencement or during the event.
- (b) All malfunctions, faulty cartridges or misfires must be recorded on the score sheet as "M" for malfunction, "R" for all refusals.
- (c) The official score must be kept on a score sheet and be available for inspection by the competitor.
- (d) It shall be the responsibility of the competitor to check his score with the score sheets before leaving the shooting tracks. Any protest on his score must be lodged with the Referee immediately, ie before leaving the shooting tracks. Such protest can only be made against incorrect score.

*Note: Scorers to be positioned in immediate proximity of the Referee using the position illustrated in the rulebook for referees.*

#### **4.23 BREAK RECOGNITION**

- (a) Break Badges will be recognised in sequences of 50, 75, 100, 150, 200, 250 and so on, provided these are shot over oscillating traps under double or single barrel conditions and in regular competition on one day only, excepting over a program of two or more successive days.
- (b) Break badges may also be similarly earned for all ISSF events, ball trap and double rise, ie 25 pairs, 50 pairs and so on, and in

Continental or Tower events provided that the break is achieved from events of the same nature.

- (c) A break in progress is terminated when a legal target is fired at and called lost.
- (d) Clubs must submit form number 17, duly completed, to the ACTA, with the prescribed fee for each requested badge, before recognition can be considered or granted. Break badges, once they have been obtained, will not be repeated. Badges for “25 metres” will also be available to those attaining this as their registered handicap.
- (e) Break badges are available for all breaks up to and including the break, in the recognised sequence, as a result of any one break.

#### 4.24 LONG BREAK RECORDS

- (a) By an Australian – may be established either in Australia or overseas providing all criteria are met. These long break records may only be established by an Australian citizen.
- (b) In Australia – may be established by any shooter competing in Australia under ACTA rules. These long break records may only be established in Australia.
- (c) Long break records will only be recognised if shot over an advertised program and the shooter has finished his event.
- (d) Any tournament from club level upwards can be used for the purpose of establishment of long break records.
- (e) Long break records are only recognised in the following Disciplines.
  - (i) Trap – Double Barrel, Single Barrel, Points Score, Double Rise, Handicap (25 Metre only), Continental DB, SB, and Points Score
  - (ii) Olympic (ISSF) Trap
  - (iii) Olympic (ISSF) Double Trap
  - (iv) Olympic (ISSF) Skeet
  - (v) Ball Trap (ACTA/FITASC/ISSF)
  - (vi) Tower
- (f) All applications for recognition of a long break record established in Australia must be accompanied by proper verification and submitted on the official ACTA form (available upon request). All applications for recognition of an Australian record established outside of Australia, besides the verification, must also have proof that all other conditions such as trapsetting were identical to the ACTA regulation standards. **Eg Amateur Trapshooting Association (ATA) rules do NOT COMPLY.**
- (g) Once a long break record is established the competitor’s name shall be recorded in the appropriate category together with the long break record score. Any competitor who subsequently equals this score shall have his name recorded alongside the current record holder(s). Any competitor who subsequently betters this score shall have his

name entered as the record holder together with the new long break record score and the previous holder(s) name(s) and score(s) shall be deleted.

- (h) The National Office shall keep a complete list, both past and present, of record holders and their scores, together with the dates established.
- (i) Any dispute over the recognition of any long break record shall be referred to the Executive Committee, whose decision shall be final.

---

# **ISSF SHOOTING RULES**

---

**To be read in conjunction with the  
ISSF Official Statutes, Rules & Regulations**

# INDEX — ISSF

## **Guidelines for officials**

Shooting rules and administration 15.1

Grading – Trap and Skeet 16.1

– Double Trap 16.2

Competition conditions 17

ISSF Postal Team Matches 17.1

Qualifications 17.2

Championships – Trap & Skeet 17.3

Championships – Double Trap 17.4

ISSF Team Matches – ISSF National Championships 17.5

Glenn Shield – Australia vs New Zealand 125 Targets 17.6

# **MANDATORY REQUIREMENTS FOR OFFICIALS**

Any reference in these rules pertaining to “him” will also mean “her”.

1. Rules for ISSF shooting competition are governed internationally by the International Shooting Sports Federation. In Australia ISSF competition is commonly referred to as Olympic discipline or trench in the case of ISSF trap. To avoid confusion ISSF is applied throughout these rules and where the terms trap, double trap or skeet occur they are to be read as ISSF trap, ISSF double trap or ISSF skeet.
2. ISSF rule and page numbers referred to below are available in electronic form in the ISSF Official Statutes and Regulations available at the below website: ([www.issf-sports.org/theissf/rules/english\\_rulebook.ashx](http://www.issf-sports.org/theissf/rules/english_rulebook.ashx))
3. ISSF Championships (Rule 16) require the presence of a Chief Range Officer, ISSF qualified Referees and qualified judges for the jury as well as the jury of appeal. The Chair of both the Jury and the Jury of Appeal should be an ISSF accredited A or B class Judge.
4. Guidelines for the accreditation of judges may be found in Article 3.12.3.9 Annex “J”, commencing page 79.
5. Guidelines for the accreditation of referees may be found in Article 3.12.2.91 Annex “S”, commencing page 95.
6. For major ISSF competitions the jury shall be appointed from (in order) ISSF A or B Class Judge, ISSF referee examiners, ISSF referees, Executive International Shooting Committee, Executive Rules Committee, Executive Committee Members and rules Supervisors on the grounds to consider issues regarding interpretation of rules, rule breaches, scoring issues and other relevant matters.
7. The Jury of Appeal shall be similarly appointed.
8. The duties of shotgun officials are outlined in ISSF Rule 9.5, those of the Juries in Rule 6.8 and Chief Range Officer is further detailed in 6.9.
9. The ISSF establishes specific standards for competition clothing and equipment that athletes must follow in ISSF Championships and for Equipment Control testing to check the enforcement of those standards to safeguard the principles of fair and equal competition where no athlete can gain an unfair advantage over other athletes (ISSF rule 6.7). In ACTA ISSF championships the shooters will be expected to adhere to the ACTA Dress Code.

# SHOOTING RULES

## SECTION 15

### 15.1 SHOOTING RULES AND ADMINISTRATION

ISSF shotgun rules are detailed within rules 9.1 to 9.19 and are available electronically in the Rule book on the ISSF website.

Technical issues are covered in Rules 6.20 commencing page 214. Safety requirements are specified in Rule 9.2.

# GRADING

## SECTION 16

### 16.1 ACTA GRADING SYSTEM FOR TRAP AND SKEET

- (a) Shall be in addition to ISSF rules in the ISSF Official Statutes and Regulations. All ACTA ISSF events may be run as graded events, where equal trophies shall be provided for each grade. Section and grade ties to be determined at the end of the last finals qualifying round and prior to the finals.
- (b) Shooters shall be graded into four classes by their percentage performance at all qualifying targets fired in competition. Targets shot in finals are not to be included for grading purposes.
- (c) **For initial grading refer Trap Rule 2.01(p)(i-vi).**  
The grades shall be: AA – 91% and over; A – 86% and under 91%; B – 78% and under 86%; C – under 78%.
- (d) It shall be the responsibility of a designated official to progressively mark the shooters ACTA Record Card and after each 250 targets, regrade the shooter as necessary. All targets to the end of the qualifying rounds but not the finals are to be used in calculation of percentage. **No re-grading will apply until the end of the club's programme of that day. Should a shooter shoot at another Club later on that day the new grade will take effect.**

*Note: if the 250 targets fall during an event, regrading will not take place until the end of the day or completion of the event if the event occurs over more than one day.*

- (e) **Any change to a shooters grade must be entered into the ACTA database by a designated club official. All changes to a shooters grade must be entered into the database within five (5) working days.**
- (f) A shooter may be upgraded after shooting 250 targets but must shoot 750 targets, 3 sets of 250 targets, at a lower percentage grade to be downgraded. All scores after the last grading must be carried forward into the new ACTA Record Card.



- (g) Until a shooter records his initial 125 ISSF targets he will be placed in the same grade as his Trap/Skeet grading under ACTA rules.
- (h) Any shooter re-registering after a period of non-registration shall be placed in the same grade as he was as when he was last registered.

## 16.2 ACTA GRADING SYSTEM FOR DOUBLE TRAP

- (a) Shall be in addition to ISSF rules in the ISSF Official Statutes and Regulations. All ACTA ISSF events may be run as graded events, where equal trophies shall be provided for each grade. Section and grade ties to be determined at the end of the last finals qualifying round and prior to the finals.
- (b) Shooters shall be graded into four classes by their percentage performance at all qualifying targets fired in competition. Targets shot in finals are not to be included for grading purposes.
- (c) **For initial grading refer Trap Rule 2.01(p)(i-vi).**  
The grades shall be: AA – 85% and over; A – 75% and under 85%; B – 65% and under 75%; C – under 65%.
- (d) It shall be the responsibility of a designated official to progressively mark the shooters ACTA Record Card and after each 300 targets (150 pairs, 2 sets of 150 targets), regrade the shooter as necessary. All targets to the end of the qualifying rounds but not the finals are to be used in calculation of percentage. **No re-grading will apply until the end of the club's programme of that day. Should a shooter shoot at another Club later on that day the new grade will take effect.**

*Note: if the 300 targets fall during an event, regrading will not take place until the end of the day or completion of the event if the event occurs over more than one day.*

- (e) **Any change to a shooters grade must be entered into the ACTA database by a designated club official. All changes to a shooters grade must be entered into the database within five (5) working days.**
- (f) A shooter may be upgraded after shooting 300 targets (150 pairs) but must shoot 600 targets (300 pairs, 4 sets of 150 targets) at a lower percentage grade to be downgraded. All scores after the last grading must be carried forward into the new ACTA Record Card.
- (g) Until such time as a shooter records his initial 50 targets (25 pairs) he shall be placed in the same grade as his current ISSF Trap grade.
- (h) Any shooter re-registering after a period of non-registration shall be placed in the same grade as he was as when he was last registered.

# COMPETITION CONDITIONS

## SECTION 17

### 17.1 ISSF POSTAL TEAM MATCHES

- (a) Trap and Skeet – the qualifying event shall be conducted over 50 targets. Teams are to consist of 6 shooters with the top 4 scores to count – the course of the team’s event is to be 50 targets. ISSF women’s and junior’s teams to consist of 4 members with the 3 best scores to count – 25 targets per team member.
- (b) Double Trap – The qualifying event shall be conducted over 30 pairs (60 targets). Teams to consist of 6 shooters, with the top 4 scores to count for men, and 4 shooters in both the women’s and junior’s teams with the top 3 scores to count.

### 17.2 QUALIFICATIONS

- (a) Each team member shall have registered in the State which he represents.
- (b) State Associations shall select their teams on the results of an elimination shoot or series.
- (c) In the event of a tie for placings it may be decided by the State Association concerned.
- (d) An appropriate High Gun shall be provided, and a souvenir badge shall be given to each member of the State team.

### 17.3 CHAMPIONSHIPS – TRAP & SKEET

- (a) Commonwealth, State, Zone and District Championships must be conducted using ISSF Official Statutes and Regulations (see Guidelines). Cartridge specifications for all ISSF events restrict shot load to a maximum of 24 grams of shot size no larger than 2.6mm. The conditions of entry for State Championships shall be the same conditions as apply for National Championships.
  - (i) District and Zone Championships to be any number of targets.
  - (ii) State ISSF Championships to be 125 targets plus finals if the State wishes the event to be accredited as an Olympic qualifying event.
  - (iii) Commonwealth & National ISSF Championships to be of 125 targets plus finals.
  - (iv) All 125 target ISSF Trap and Skeet Championships should include final rounds in accordance with ISSF rules for the top 6 shooters to determine the first 3 placings.
  - (v) All Trap grade shoot-offs will be shot single barrel, miss and out. To be squad system.
- (b) All ISSF events may be run as graded events, where equal trophies shall be provided for each grade. Section and grade ties to be shot off after qualifying rounds and prior to the finals.

#### **17.4 CHAMPIONSHIPS – DOUBLE TRAP**

- (a) Commonwealth, State, Zone and District Championships must be conducted using ISSF Official Statutes and Regulations. Cartridge specifications for all ISSF events restrict shot load to a maximum of 24 grams of shot size no larger than 2.6mm. ACTA grading system shall be in addition to ISSF shooting rules. The conditions of entry for State Championships shall be the same conditions as apply for National Championships.
  - (i) District and Zone Championships to be 15 pairs or 30 pairs.
  - (ii) State Championships to be 75 pairs (150 targets) plus finals if the State wishes the event to be accredited as an Olympic qualifying event.
  - (iii) Commonwealth & National ISSF Championships to be of 75 pairs (150 targets) plus finals.
  - (iv) All State, Commonwealth and National Double Trap events shall include final rounds in accordance with ISSF rules for the top 6 placings to determine the first 3 placings.
- (b) All Double Trap events may be run as graded events, where equal trophies shall be provided for each grade. Section and grade ties to be shot off after the qualifying rounds and prior to the finals.

#### **17.5 ISSF TEAM MATCHES – ISSF NATIONAL CHAMPIONSHIPS**

- (a) Interstate Shoulder to Shoulder teams matches will be conducted at the ACTA ISSF National Championships for men, women's veteran's and junior teams in trap and skeet.
- (b) Team events shall be as follows:
  - Men, Women, Veteran and Junior Trap/Skeet Teams are to shoot 125 targets in conjunction with the respective National ISSF Championships.
  - Mens Team three(3) members, Womens Team three(3) members, Veterans Team two(2) members, Junior Team two(2) members.
  - The age for Veterans is over 55 years of age on the 1st of January in the year of the National Championship. The age for Juniors is under 21 in the year of the National Championship.

#### **17.6 GLENN SHIELD Calrossie/McKenzie Trophy – AUSTRALIA VS NEW ZEALAND 125 TARGETS**

- (a) Shot in conjunction with the National ISSF Trap Championship.
- (b) In the event of a tie, the winning team will be determined by count back, as per ISSF rules.
- (c) Three members are selected from the Junior High Guns to represent the Australia Team in ISSF Trap comprising 250 targets.
- (d) In the event of a tie, the top 3 places in the team shall be decided by count back.

- (e) Should there be a tie for team scores they will also be determined by count back.
- (f) Shot in Australia Odd years, New Zealand Even Years.

---

**SKEET**

---

# GENERAL INDEX — SKEET

\* MROS = Mandatory Requirements for Officials, Skeet.

- Abide by result 5.10
- ACTA Record Card — handicap 6.01(a) (i) (j) (k) (m) (n)
- ADMINISTRATION SECTION 8: 8.01 to 8.25
- Age 8.11
- Alter decision (Referee may) 5.09(d)
- Ammunition — challenge by Referee 8.18(d) (e)  
— malfunction of 5.06(b)(iv)
- Appeal — against Referee's decision 8.14(c)
- Australian N.Z. Teams Match 7.07  
—Interstate teams match 7.13
- Australian Skeet Handicap 7.04
- Australian Skeet 20 gauge Championship 7.05
- Australian Skeet Champion of Champions 7.06
  
- Bad weather/Darkness 8.15(c)
- Barrels MROS. 1 & 8.08(c)
- Barrel obstruction MROS 1
- Barrel length 8.08(c)
- Baulk 5.09
- Bet — not to make 5.02(i)
- Break recognition 8.23  
— long break records 8.24
- Broken targets — definition 5.04
  
- Cartridges 8.09  
— not to leave in gun MROS 9 & 5.01(k) (l)  
— when to put in gun 5.01(l)
- Cash distribution 5.15
- Catching-up 8.12
- Challenge 8.14
- Championship sashes, badges, trophy 7.12
- Check Referee 8.18(b)
- Clerical error on ACTA Record Card 6.03(b) to (e)
- Commonwealth events 7.08
- COMPETITION CONDITIONS SECTION 7: 7.01 to 7.12
- Competitor — competition 8.10(d)  
— disqualified/withdraws 8.10(h)
  
- Darkness — bad weather 8.15(c)
- Delay a squad (shooters not to) 5.02(d)
- Describe event MROS 3
- Disorderly manner 8.15(a)
- District (club) events 7.11
- Disturb member shooting MROS 13

- Doubles events — rules — procedures 5.12
- Dress 5.02(l)
- Dusted targets 5.05
  
- Empty shells 5.02(h)
- Entrance fees — at Nationals 7.01
- Event ties — skeet 7.14
  
- Fauna — not to shoot 5.01(m)
- Firearms & loads 8.08, 8.09
  - to remain open 5.01(e)
- Firing point — competitor shall close gun 5.01(k)
  - competitor to be at 5.02(a)
- Foot violation — competitors 5.08(d)
  
- Gauge — not to be larger than twelve 8.08(c)
- Grades 6.01(e)-(m)
- Gun
  - breaks down 5.08(c)
  - not to close 5.02(g)
  - not to open after misfire MROS 12, 5.08(c)
  - to be open 5.01(a)
  
- Handicap — ACTA Record Card 6.01
  - events 5.13
  - sweepstakes 5.14
  - failure to produce 6.01(f)
  - return to ACTA in 14 days 6.03(f)
- HANDICAPPING/GRADING SECTION 6: 6.01 to 6.03**
- Handicapping formula 6.01, 6.02
  - adjustments 6.03
- High-gun shoot-offs 7.15
  
- Illegal target 5.08(h)
- Interstate teams' matches 7.13
  
- Jackpots 5.15(f)
- Junior 8.11(a)
- Jury 8.16
  
- Legal target 8.04, 8.05, 8.06
- Loads 8.09
- Lost target MROS 8, 5.08
  
- Malfunction MROS 12, 5.01(f), 5.07(g)
- Management 8.15
  - misleading 6.01(l)
- Misfire — malfunction 5.01(f), 5.06(b)(iv), 5.06(c), 5.08(c)
- Mobile Phones — not to be audible 5.01(n)

- Names MROS 1
  - correct names to be used 8.10(g)
- National Championships
  - High Guns 7.15
  - Skeet 7.02
  - Skeet Doubles 7.03
  - Skeet Handicap 7.04
  - Skeet Champion of Champions 7.06
  - Skeet 20gauge / 28gauge / 410gauge 7.05
- No target 5.06, 5.07
- Open shoots 8.10(a)
- Orthodox gun position
  - firing of gun 5.01(d)
- Physical disability 6.01(r)
- Powder
  - loads 5.01(h)
- Practice 8.12(a)
- Procedure 5.02
- Proof Doubles 5.07
- Pull
  - calling for target 5.02(c)
- Reciprocal rights 8.10(i)
- Red signal from traphouse MROS 9, 5.01(l)
- Referee
  - appointment for 5 years 8.17(d)
  - complaints against 8.17(c), see 8.21(e) (f)
  - decision 8.17(e)
  - duties of 8.18
  - examiner — complaints against 8.21(e)
  - examiner — duties of 8.20
  - how to become 8.17(a)
  - may alter decision 5.09(d)
  - positioned in the skeet field 8.22(e)
  - record to be kept by Rules Sup. 8.17(b)
  - to call result MROS 7
  - to release target immediately MROS 6
  - view 5.03(e) (g)
  - where to stand MROS 2
- Referee & Scorer 8.22
- Refusal rule MROS 15, 5.06(a)
- Regular double 8.05
- Release trigger 5.01(g), 5.01(r), 8.08(b)
- Re-registering 6.01(p)
- Rules supervisor— duties of 8.21
- Safety 5.01(a) to (r)
  - rule MROS 10, 5.01(i)
- Safety catch MROS 12, 5.06(b)(vii), 5.08(b)
- Sashes 7.12
- Scorer
  - where to stand MROS 4, 8.22(e)



- Scorer & Referee 8.22
- Shoot Marshall — duties of 8.19
- Shooting — CTSN/certain events to be advertised 8.10(a) (b) (c)
  - on grounds — when not to 5.01(c)
  - field 8.01(a)
- Shooting position 5.02(e)
- SHOOTING RULES SECTION 5: 5.01 to 5.15
- Signed directive on ACTA Record Card 6.03(i) (j)
- Simultaneous discharge 5.06(b) (v)
- Six man squad 5.03(a)
- Skeet field layout 8.01
- Skeet round procedure 5.11
- Skeet shooting bounds 8.02
- Squad — shooters to remain as MROS 16, 5.02(j)
- Squads 5.03
- State events 7.09
- Station — not to proceed to 5.03(f)
- Sun — no baulk 5.09(c)
- Sweepstakes deduction 5.15
- Sweepstakes
  - cash distribution 5.15
  - handicap 5.14
- Target
  - different colour 5.06(b)(vi)
  - illegal MROS 15, 5.03(g)
  - to be shown by Referees MROS 5
  - to be thrown 5.02(b)
  - to call for within 10 seconds 5.02(d)
- Targets 8.06
  - legal skeet 8.04
  - only 8.13
  - regular double 8.05
  - squad to observe 5.03(e)
  - & trap adjustments 5.03(b) (c)
- Ties 7.14
- Trap
  - adjustment 5.02(k), 5.03(b) (c)
  - don't interfere with 8.18(f)
  - house 8.03
  - to be adjusted immediately 5.03(b), 8.18(f)
- Traps 8.07
- Underhandicapped/undergraded 6.03(g)
- Unsportsmanlike — disorderly 5.01(j), 8.15(a) (b)
- Unload your guns etc MROS 17
- Unregistered shooters
  - not to compete 8.10(f)
- Veteran 8.11(c)
- Zone events 7.10

# **MANDATORY REQUIREMENTS FOR OFFICIALS, SKEET**

Any reference in these rules pertaining to “him” will also mean “her”.

1. Read shooters’ names from squad sheets. Ensure competitors are lined up in the correct order beside station one. For safety reasons ask all shooters to check for obstructions in barrels.
2. The Referee must stand where he has a clear view of targets and competitors. The Referee should stand in the position indicated in the field diagram.
3. Describe the event and procedure for conduct of the event, eg “25 Target Skeet Championship.”
4. The Referee should ask his Scorer to stand close enough to him so that the Referee can see the score sheet, and the Scorer can observe the target as a check Referee.
5. Target to be shown by Referees,
  - (a) At the beginning of each round the SQUAD shall be entitled to observe one (1) high house, one (1) low house and one (1) pair of double targets and shall have the option of observing one regular target after each illegal target.
  - (b)
    - (i) After any breakdown or delay
    - (ii) At the commencement of all shoot-offs
    - (iii) On each trap used for a shoot-off
    - (iv) After any break for shells etc during a shoot-off
    - (v) If a competitor receives two broken targets in a row.
  - (c) There will be no sighter (eye-opener) targets to be shot at by any shooter.
6. The Referee must at all times ensure that the target is released immediately on the competitor’s call.
7. The Referee must clearly call the result thus: one, lost, no target, as appropriate.
8. Lost targets must be called immediately, and the Referee must change his decision if the target breaks before it hits the ground.
9. At all times ensure that no competitor leaves a cartridge(s) in his gun after a red signal from the traphouse (breakdown etc).
10. The Referee must speak to a shooter immediately on any breach of the safety rules. If the rules of etiquette are broken the Referee should speak

to the shooter concerned after the squad has finished, depending on the circumstances.

11. Where applicable the Referee must ensure that one cartridge only is placed in the gun.
12. The Referee must not restore a target if the competitor opens his gun after a malfunction. In the case of a malfunction the Referee shall visually check the safety catch is not in the on position and that the action is closed. He will request the shooter to test fire the gun once only. Under no circumstances will the Referee attempt to test fire the gun.
13. The Referee should be mindful of the rule regarding squad members disturbing the competitor shooting.
14. A Referee will not call no target to deny a shooter the opportunity to shoot at a whole target unless a safety hazard exists. The shooter is the only person to decide if the target is acceptable to him.
15. Interpretation of refusal rule:
  - (a) A shooter may refuse to shoot at any target which he considers to be illegal.
  - (b) There is no limit to the number of targets the shooter may refuse as long as the Referee agrees with the reasons. Obviously, if too many targets are refused for illegality, the Referee must find the cause, then correct it. If the Referee does not consider that the target refused is illegal, he will ask the shooter why he refused the target. If the Referee is not satisfied with the reason he will tell the shooter. He will also state that any further targets which are refused, and are considered by the Referee to be legal will be scored "Lost Target". If the above situation seems likely to arise, it is preferable that a third party, qualified if possible, adjudicates subsequent refusals. The foregoing procedure in no way discriminates against Referees . It is meant to assist in equity of competition. A major point missed by Referees is that although a shooter may refuse to shoot at an illegal target, he is equally entitled to accept an illegal target. However, if he shoots at and misses an illegal target, the only decision open to the Referee is "Lost Target". Similarly, if he hits it, abide by result.
  - (c) A Referee should not call "No Target" for a fast or slow released target, nor if the target seems to him to be too high, too low or too wide. "No Target" should only be called in the case of a broken target or where a safety hazard exists if a shooter elects to shoot at the target.
  - (d) Referees are to ensure that "R" for refusal is entered on Score

Sheets. Every refusal must be called either “No Target” or “Lost Target” by the Referee.

16. The Referee is to see that all competitors remain as a squad until the last shooter has finished.
17. At the completion of each visit to a field the Referee must request competitors ensure that their guns are safe and their scores are correct.

# SHOOTING RULES

## SECTION 5

### 5.01 SAFETY

- (a) All guns must be immediately opened upon removal from a gun rack or car to determine that they are indeed empty.
- (b) All guns carried on or about the shooting ground must be held in a position of safety, with the breech open and unloaded at all times.
- (c) Shooting on the grounds at any place other than the firing point at legitimate targets only is prohibited except where a pattern plate is installed, and then only with permission of Club Management.
- (d) Firing the gun in any position other than orthodox, ie to the shoulder, is prohibited (with the exception of a physical disability). Any shooter firing a gun from any position other than orthodox will be immediately suspended by the Club Management and reported in writing to the Executive Committee – a minimum penalty of three months suspension shall apply.
- (e) All guns must remain fully open until the shooter is in the shooting station
- (f) Shooters experiencing a misfire or malfunction must remain with their gun pointed in a safe direction until the Referee adjudicates.
- (g) Release trigger guns shall not be left in gun racks or in positions where they can be handled, but shall be constantly under the control and supervision of the user and shall be labelled as per Rule 8.08(b)iii.
- (h) Powder loads for re-loads must not exceed the manufacturer's recommended specification. Shooters exceeding the recommended load shall be deemed to be in breach of the safety regulations.
- (i) Any shooter knowingly breaching any safety rule other than 5.01(d), will be immediately suspended by the Club Management for one (1) calendar month pending an investigation into their actions by the relevant State Association and the ACTA must be notified of all breaches and responses.
- (j) Any shooter committing an unsportsmanlike or unsafe act on the shooting ground shall be liable to suspension or disqualification.
- (k) When it is his turn to shoot, the competitor shall stand on the shooting station, load and close his gun. He must open his gun and remove the cartridges before turning or leaving the shooting station.
- (l) The shooter will not insert a cartridge in his gun until he is on the shooting station, at his turn. All cartridges must be removed from a gun upon the red signal at the skeet house, or if any official approaches the skeet houses on that layout.
- (m) Any shooter deliberately firing at any fauna on any shooting ground shall be immediately suspended by the Club Management and

shall remain suspended until the incident is dealt with by his State Association.

- (n) Mobile Phones or like devices must not be audible during competition.
- (o) Hearing and eye protection is strongly recommended for all ACTA disciplines whilst present at the firing point or trap area.
- (p) Gun sleeves and slings are not permitted to be used in any ACTA discipline.
- (q) A gun must not be used that will accept more than one gauge of cartridge at the same time and a gun must not be loaded with different gauge ammunition.
- (r) A release trigger is not to be set until the gun is mounted to the shoulder. Failure to comply will incur a warning in the first instance and disqualification from the event for a second offence.

## **5.02 PROCEDURE**

- (a) A competitor must be at the firing point within two minutes of being called. Failing this he may be disqualified, penalised with loss of targets, or be re-squadded at the discretion of the club.
- (b) A target must be thrown for the first shooter on his call at his first and subsequent visit to each trap, or after a break in shooting.
- (c) When at the firing point ready for competition, the competitor shall distinctly give the command "pull" or a similar command to the Referee and thereafter the competitor is in the competition.
- (d) It shall be considered a time infringement if a shooter deliberately delays more than 10 seconds for each shot on a station and the Referee shall warn him/her once each round without penalty. Subsequent occurrences per round will be penalised one target each. This rule should be interpreted in conjunction with rule 8.12(c) which indicates that a squad should complete a round of Skeet in 20 minutes.
- (e) For Skeet, the shooter must stand with any part of both feet within the boundaries of the designated shooting station.
- (f) Provided he is standing on the shooting station and it is his turn to shoot, a competitor may place cartridges into the breech.
- (g) Shooters must not close or attempt to mount the gun to the shoulder until he is standing on the shooting station
- (h) Empty shells on the ground must not be collected whilst shooters are on the field. Only those people directly associated with the competition will be on the field whilst the shoot is in progress.
- (i) No competitor shall make, negotiate or discuss any bet (either on his own shooting or that of any competitor) whilst he is on the shooting station. If any competitor infringes this rule, he may be disqualified by the Referee.
- (j) All members in a squad must remain as a squad until the last competitor has shot.

- (k) The officiating Referee or the Management must have the traps adjusted immediately if they are not throwing legal targets. Immediately following such alteration a target must be thrown and the competition continued.
- (l) All competitors are required to dress in an appropriate manner. The wearing of camouflage clothing (any version), singlets or singlet style sleeveless tops is prohibited. The wearing of thongs, scuffs or bare feet is prohibited. Any shoes worn must have a restraining strap or support at the heel. The wearing of high cut shorts is prohibited.

### 5.03 SQUADS

- (a) A normal skeet squad is composed of five shooters. Any five shooters may designate themselves as a squad. All shooters shall be formed into squads of five shooters each, as nearly as possible. Less than five shooters is permitted for expedience, but more than six should not be squadded for safety reasons, except in shoot-offs, see rule 7.14(a).
- (b) The officiating Referee MUST have the trap adjusted immediately if it is not throwing legal targets. Immediately following such alteration, a target must be thrown and the competition continued. Unauthorised shooters must not interfere with or attempt to interfere with the setting of the traps. Violation of this rule may be grounds for disqualification from the event.
- (c) The competitor whose turn it is to shoot may observe a legal target from a traphouse where the trap has been adjusted or repaired, or where an illegal target has been released.
- (d) No competitor shall unduly delay a squad without good and sufficient reason in the judgement of the Referee in charge of the squad. A shooter who persists in deliberately causing inexcusable delays after receiving a first warning from the Referee shall be subject to disqualification from the event.
- (e) At the beginning of each round the SQUAD shall be entitled to observe one (1) high house, one (1) low house and one (1) pair of double targets.
- (f) No member of a squad having shot from one station shall proceed toward the next station in such a way as to interfere with another shooter. The penalty for wilful interference in this manner shall be disqualification from the event. However, when in the opinion of the Referee it is done unobtrusively, the first competitor in a squad should be allowed to move across and stand at least three metres behind the next station from Station 2 to 6 inclusive.
- (g) The Referee shall ensure that the target is released “instantly” (see Rule 8.04(a)) in response to the competitor’s acceptable call. If a shooter fires at what is considered to be an illegal target, due to the timing of the release, he must abide by the result. The Referee shall have an uninterrupted view of the competitors at the firing points.
- (h) While shooters may request to be squadded in the same wave as

other shooters, under no circumstances will a shooter be allowed to nominate a particular squad number or skeet layout. Shooters may be squadded in order of nomination.

#### **5.04 BROKEN TARGETS**

A broken target is one which has a visible piece broken from it, whilst in the air, by the shot from the competitor's gun.

#### **5.05 DUSTED TARGETS**

A "dusted target" is one from which dust is detached by the competitor's shot, but which shows no visible piece broken from it. A dusted target is not a broken target and is a "lost target".

#### **5.06 NO TARGETS**

After "no target" has been called by the Referee under any of the following conditions it thereafter plays no part in the competition and is irrelevant to it.

- (a) No target shall be called when a target is refused for the following reasons:
  - (i) A target is released without the competitor's call and the target has not been fired at.
  - (ii) A time interval occurs before or after the competitor's call unless the target is fired at.
  - (iii) A target does not conform to the definition of a legal target and the target has not been fired at.

*Note: If in the opinion of the Management, an excess of refusals is recorded, the Management has the right to check the shooter, Referee and equipment. If in the opinion of the Referee, legal targets are being refused, the Referee may call "lost target". All refusals must be recorded on the score sheet as "R".*

- (b) "No target" shall be called when:
  - (i) A broken target is released.
  - (ii) In singles, if by error or for mechanical reasons doubles are thrown and the shooter shoots and breaks or misses the correct target, it shall be scored as in singles. It shall be the shooter's prerogative to elect to shoot or withhold his shot when doubles are thrown in the calling of singles.
  - (iii) The Referee may grant a shooter permission to shoot out of turn where it is justified in the interest of saving time.
  - (iv) A malfunction occurs in either barrel caused by the competitor's gun or misfire of a cartridge due to no neglect on the competitor's part.
  - (v) A simultaneous or near simultaneous discharge occurs, ie, from any cause both barrels are discharged together or nearly together. Simultaneous discharges shall be recorded as a malfunction.



- (vi) A different coloured target than being used for the event is thrown and not fired at. Firing at the target shall cause it to be considered a legal target with the result to stand.
- (vii) No target shall be allowed for the first target of any visit to a trap if a safety catch is engaged.
- (c) The following are considered malfunctions of ammunition:
  - (i) Failure to fire when firing pin indentation is clearly visible;
  - (ii) When only the primer fires – or is missing;
  - (iii) When the powder charge has been omitted;
  - (iv) When the powder charge is not ignited;
  - (v) Components of the load remain in the barrel.
  - (vi) All misfires and malfunctions must be marked on the score sheet as “M”.

### **5.07 NO TARGET – DOUBLES / PROOF DOUBLES**

- (a) If the first target emerges broken, the doubles shall, in all cases, be declared no targets (both) and a proof double shall be thrown to determine the result of both shots.
- (b) If a double is thrown but the targets collide, before the result of the first target is determined, they shall be declared no targets (both) and the result of a proof double shall determine the score of both shots.
- (c) If the first target of a double is thrown irregular as to deviate from the prescribed line of flight and is not shot at, a proof double shall determine the score for both shots, whether the second target is fired upon or not. The Referee shall be the sole judge of irregularity.
- (d) If the first target of a double is thrown irregular as to deviate from the prescribed line of flight, and is shot at, the result shall be scored for the first shot, and if the shooter is deprived of a normal second shot for any of the reasons in Rule 5.07(e), the second target only shall be declared no target and a proof double shall be thrown to determine the result of the second shot.
- (e) If the shooter is deprived of a normal second shot for any of the following reasons, the result of the first shot shall be scored, and the second target only shall be declared no target and a proof double shall be fired to determine the result of the second shot.
  - (i) The second target is thrown broken.
  - (ii) The second target is thrown irregular as to deviation from the prescribed line of flight and is not shot at.
  - (iii) The second target is not thrown at all.
  - (iv) The second target is not thrown simultaneously.
  - (v) Both targets are broken with the first shot.
  - (vi) The wrong target is broken with the first shot.
  - (vii) The first shot is lost and a collision occurs before the result of the second shot is determined.

- (viii) The second target collides with fragments of the first target properly broken, before the result of the second shot is determined.
- (ix) The result of the first shot is determined, and interference occurs before the second shot is fired.
- (f) There shall be no penalty for withholding the first shot when either target of a double is irregular. A proof double shall determine the score of both shots thereafter.
- (g) If a double is thrown and an allowable malfunction occurs on the first shot, it shall be declared no target, and the result of a proof double shall determine the score of both shots. If such malfunction is excessive (not allowable) the proof double shall be thrown to determine the result of the second shot only.
- (h) In shooting a proof double after the first target (of a double) is lost, if the shooter fires at or breaks the wrong target first, said proof double shall be scored as both targets lost. If in such a proof double after the first target (of a double) is broken, the shooter fires at, or breaks, the wrong target first, it shall be scored as first target broken and second target lost.

## **5.08 LOST TARGET**

Lost target shall be called when:

- (a) A competitor fails to break a legal target.
- (b) The competitor fails to shoot because his gun is unloaded, or because the safety was incorrectly set or jarred back, whether from his oversight or not, or because of any other cause chargeable to his oversight or neglect (no target shall be allowed for the first target of any visit to a trap if a safety catch is engaged). Should this happen in doubles, the first target only should be declared lost and a proof pair shall be thrown to determine the result of the second shot only. However, a shot shall be fired at each target in the proof pair.
- (c) The competitor has an apparent malfunction and attempts to open the gun before the Referee examines it. The competitor must not turn around and must keep his gun pointed in a safe direction until the Referee has given his decision. If a competitor's gun breaks down and it is necessary to seek a replacement the competitor is allowed five (5) minutes to do so. If this is not possible the competitor may leave the squad and finish the remaining targets of the round at a time decided by the Management. Should a gun malfunction occur during a shoot-off, the competitor has 10 minutes to repair or replace the gun. Failure to comply "Lost target".
- (d) A foot position violation occurs. The shooter must stand with any part of both feet within the boundaries of the designated shooting station.

- (e) The fourth and subsequent malfunction in any one event occurs. However, at the end of each 100 targets in any one event, the malfunctions that have occurred shall be cancelled, and the count shall re-commence from zero.
- (f) A target is dusted.
- (g) A whole target was fired upon and missed.
- (h) An illegal target was fired upon and missed.
- (i) When the competitor breaks a target outside the skeet range shooting bounds.
- (j) Targets shot at are broken after they pass the centre from No.8 Station are lost targets.
- (k) Doubles shot in reverse order shall result in the loss of the first target and a proof double required to determine the result of the second target.
- (l) One shot only shall be allowed at each target. Intentionally firing twice at the same target, whether hit or missed by either shot is a lost target. Furthermore, the shooter is warned that the second time the shooter intentionally fires at the same target in any event, the penalty shall be automatic disqualification from the event. Firing at chips is not allowed.

#### **5.09 BAULK**

- (a) Any extraneous occurrence, which in the opinion of the Referee materially interferes with the equity of the competitor after he calls for his target constitutes a baulk.
- (b) If a shooter fires a shot and the appearance of a target or piece of target from an adjoining field appears, it shall not be ruled as a BAULK unless the target or piece of target strikes or threatens to strike the shooter or the shooters gun. The referee is the sole judge as to whether a baulk has occurred or not.
- (c) The sun shall not be considered as interference. It must be considered as a normal hazard.
- (d) Under no circumstances will a baulk be granted unless claimed by the competitor immediately it occurs, and/or in the opinion of the Referee, a baulk has occurred, he may restore the competitor's target.
- (e) The Referee has power to alter his decision. This must be done before the shooter in question shoots his next target or the shooter leaves the tracks should this be his last target.

#### **5.10 ABIDE BY RESULT**

Should there be a faulty cartridge, misfire or malfunction in the first barrel, in singles, and the competitor fires the second barrel where possible, the competitor shall abide by the result. In doubles if there be a faulty cartridge, misfire or malfunction in the first barrel and the competitor fires the second barrel where

possible, the competitor shall abide by the result, with the first target to count and a proof pair thrown to determine the result of the second target. If a shooter does not fire at the first legal target of a double but shoots at the second target, the result of the first target will be declared lost and a proof pair thrown to determine the result of the second target.

### **5.11 ROUND PROCEDURE**

- (a) A squad shall start shooting at Station 1 in the order in which the names appear on the score sheet. The first shot scored lost in the round shall be repeated immediately as the optional shot and recorded in the 25th column on the score sheet. If the first target of a double is the first lost target, and a proof double is required for any reason to determine the result of the second target, then the proof double procedure shall be completed and then the first target shall be repeated as a single and scored as the 25th shot.
- (b) The first shooter shall start shooting singles at Station 1, shooting the high house target first and the low house target second. Then, loading two shells, he/she shall proceed to shoot doubles, shooting the first shot at the target from the high house and the second shot at the target from the low house, before leaving the station. The second shooter shall then proceed likewise, followed by the other members of the squad in their turn.
- (c) Then the squad shall proceed to Station 2 and repeat the same sequence as on Station 1.
- (d) The squad shall then proceed to Station 3 where each shooter will shoot at a high house single target first and a low house single target second before leaving the shooting station.
- (e) The same procedure shall be followed at Station 4 and 5.
- (f) Upon advancing to Station 6 the leadoff shooter will shoot singles in the same sequence as at the previous stations. Then, loading two shells, he shall shoot doubles by shooting the low house target first and the high house target second before leaving the station. The other shooters will follow in their turn.
- (g) The same procedure will be followed at Station 7.
- (h) The squad will advance to Station 8 where each shooter shall shoot at a target from the high house before any member of the squad shoots at a target from the low house.
- (i) The squad shall then turn to Station 8 low house and the leadoff shooter will shoot at the low house target.
- (j) The shooter shall repeat the low house target for his optional shot before leaving the station, provided he is still straight (no lost targets in the round). The other shooters will follow in turn.
- (k) At this time the shooter should verify his own score.
- (l) During the shooting of single targets a shooter may load 2 shells except at Station 8 high house, or for the last single target on any station, or unless prohibited by club rules.

## **5.12 RULES AND PROCEDURE FOR DOUBLES EVENTS**

- (a) Open Double Championships shall be shot at 25 pairs or multiples of 25 pairs.
- (b) Uneven numbered rounds ie Rounds 1 and 3: Commencing on Station 1 and proceeding through Station 4, a double is to be shot from each station, taking the high house first. On Stations 5, 6 and 7 a double is to be shot taking the low house first. Reversing back through Stations 6, 5 and 4 a double is to be shot taking the low house first. On Stations 3 and 2, a double is to be shot taking the high house first. Total number of targets = 24. Even numbered rounds ie Rounds 2 and 4: To be shot as in uneven numbered rounds but finishing on Station 1. Total number of targets = 26.
- (c) The rules for double in a Doubles event are the same as the rules for doubles in a regular round of Skeet.
- (d) Clubs have the option of conducting a 25 target event. This event will be the same as an uneven numbered round with the addition of a single high house target immediately following the concluding double from Station 2.

## **5.13 HANDICAP EVENTS**

Each competitor will commence the shoot-off with a handicap allowance equivalent to the surplus of his ACTA handicap remaining after qualifying for the shoot-off and will continue in the shoot-off until he has lost one target in excess of the handicap allowance irrespective of the length of the shoot-off.

Examples:

- (a) 25 target event. A competitor whose ACTA handicap is 5 shoots 22-25. He will commence the shoot-off with a handicap allowance of 2 and will be eliminated immediately he loses one target in excess of the allowance. Should he shoot 23-25 in the first round of the shoot-off he will commence the second round with an allowance of 0 targets.
- (b) 50 target event. A competitor whose ACTA handicap is 5 shoots 42-50. He will commence the shoot-off with a handicap allowance of 2 and will continue in the shoot-off as in (a) above.

## **5.14 SWEEPSTAKES ON HANDICAP EVENTS**

The normal method in a Skeet Handicap is to divide the sweepstakes amongst those shooters attaining twenty-five broken targets, with handicaps included:

Example:

Smith 25-25, handicap 3 total = 25-25

Jones 22-25, handicap 3 total = 25-25

Brown 20-25, handicap 5 total = 25-25

## **5.15 SWEEPSTAKES DEDUCTION AND CASH DISTRIBUTION**

- (a) Clubs have the option of taking 60% in cash divide events.

- (b) No deduction is permitted by clubs in optional sweepstakes.
- (c) In all sweepstakes, distribution shall be on the basis of 60% (1st), 30% (2nd), 10% (3rd). A competitor scoring the only possible in the event wins only 60% (1st place). All optional sweeps shall be compulsory division as in the above formula. The Management shall clearly indicate on the official score sheet or scoreboard those who have entered for the optional sweep. When running Graded Sweeps/ Cash divide each grade monies to be divided between that grade.
- (d) Sweepstakes at State Carnivals or Championships may be decided by the State concerned. State Associations have the option of conducting either compulsory or optional sweepstakes at State Carnivals.

Note: In all events, including handicap events, for cash prizes or trophies excluding sweepstakes, trophies and placing's shall be decided by shoot-off. The grading and handicap formula will apply.

- (e) The inclusion of either compulsory or optional sweepstakes at National Championships and their method of division to be at the discretion of the Executive Committee. Sweepstakes at any competition shall be determined by scores off the gun and shootoffs shall not apply.
- (f) Jackpots must be determined in the manner for when and which they are introduced.

# HANDICAPPING/GRADING

## SECTION 6

- 6.01** (a) All appropriate scores shot in a 12 gauge event shall be recorded in the skeet column for percentage performance classification irrespective of how the event is run. All other gauges and Doubles scores must be entered into the designated doubles column to be transposed for all inferior scores in the skeet column once the shooter has shot 200 12 gauge competition skeet targets.
- (b) A graded event is a competition event in which all the competitors shoot and prizes are allocated for various grades of competitor.
- (c) Shooters shall be graded into four grades by their percentage performance over all targets fired upon in competition day or night, including shoot-off targets.
- (d) Clubs shall have the option of running all Championships other than State or Commonwealth Championships either as graded events or as one class events.
- (e) Grades shall be: AA 97% and over; A 94% and under 97%; B 87% and under 94%; C under 87%.
- Note: Club Managements have the option of shooting D Grade under 80%.*
- (f) Shooters failing to produce their ACTA Record Card at competition shoots shall pay a \$20.00 penalty fee to the club.
- (g) Club Managements have the option of running common mark events OA,AA,A,B,C; AA,A,B,C; First, Second, Third; or by combining, AA & A.or A & B or B & C grades.
- (h) It shall be the responsibility of a designated club official to enter individual event scores and progressively mark the shooter's ACTA Record Card with results. If the 200 targets fall during an event or shoot-off, regrading will not take place until the completion of that event. All targets to the end of that event and shoot-off targets are to be used in calculation of percentage.
- (i) A shooter must shoot a minimum of three (3) consecutive groups of 200 targets, ie 600 targets, at a lower grade percentage to be down graded, other than in the authority vested in Rule 6.03(g). Once attaining A grade a shooter cannot be regraded to C grade and once attaining AA grade a shooter cannot be regraded to B grade, other than in the authority vested in Rule 6.03(g). A shooter can only be downgraded one grade at a time. All scores after the last grading must be carried forward onto a new ACTA Record Card.
- (j) Shooters awaiting the issue of a ACTA Record Card after registering for the first time shall be allowed to enter in any competition. Scores shot during this period must be kept and entered on his ACTA Record Card when received.
- (k) If a shooter has misplaced or lost his ACTA Record Card he shall be allowed to compete providing he is registered with the ACTA.

He shall be allowed to compete in his grade and in handicap events as claimed. Should he win prize money or trophies they must be retained by the club until such time as the shooter presents his ACTA Record Card to the club for marking.

- (l) Should it be found that the shooter has claimed the wrong handicap or grade, the Club shall advise the State Association so that the matter may be investigated. If it is determined that the shooter deliberately misled the Club Management regarding his grade and/or his handicap, the shooter will be suspended for three (3) months.
- (m) A shooter must not shoot in a grade higher than his best performance. Once having attained a grade he may elect to remain in that higher grade when due for regrading. If he so elects he must remain in that grade for the next three groups of 200 targets. If the shooter so elects his ACTA Record Card must be marked to indicate such. Eg: Prefer A grade.
- (n) All wins shall be recorded with a OW (overall) or GW (grade) beside scores on ACTA Record Cards.
- (o) Managements conducting graded events shall provide a minimum of one prize or trophy for each grade.
- (p)
  - (i) New shooters without prior competitive shotgun experience will be placed in C grade by the Club for the first 50 competition targets. At the completion of these first 50 targets they will be given a provisional grade and the targets shot will become part of the first 200 targets for grading purposes.
  - (ii) Shooters re-registering after an absence will be placed in the grade and on the handicap in which they left the ACTA for the first 50 competition targets. At the completion of these first 50 targets they will be given a provisional grade and the targets shot will become part of the first 200 targets for grading purposes.
  - (iii) Shooters registering with experience in another shotgun code (eg Field & Game) will be placed in the same grade as their current grade in that code for the first 50 competition targets. At the completion of these first 50 targets they will be given a provisional grade and the targets shot will become part of the first 200 targets for grading purposes.
  - (iv) Shooters re-registering after an absence who have subsequently been shooting competition in other shotgun codes will be placed in the same grade as their current grade in that code for the first 50 competition targets. At the completion of these first 50 targets they will be given a provisional grade and the targets shot will become part of the first 200 targets for grading purposes.
  - (v) Shooters when first competing in any ACTA discipline who already have any existing ACTA grade will be placed



in the highest grade and handicap achieved at any other ACTA discipline for the first 50 competition targets. At the completion of these first 50 targets they will be given a provisional grade and the targets shot will become part of the first 200 targets for grading purposes.

- (vi) In each of the above 4 circumstances where an event/events progress past the first 50 targets the shooter will be graded on these event targets, they will be given a provisional grade and the targets shot will become part of the first 200 targets for grading purposes.
- (q) Upgrading of shooters after the initial 200 targets is limited to one grade at a time.
- (r) A competitor may apply through the State Handicapper for downgrading due to proven physical disability.
- (s) No re-grading or re-handicapping will apply until the end of the club's programme of that day. Should a shooter shoot at another Club later on that day the new grade/handicap will take effect.

## 6.02 HANDICAPPING FORMULA

- (a) Until such time as a shooter has completed 200 targets their provisional handicap will be aligned to their grade as established under Rule 6.01(p) and the percentages under 6.02(b)
- (b) After shooting the next 200 targets and each successive 200 targets the shooter's handicap and grading shall then be adjusted according to the handicap and grading formula. A shooter must shoot a minimum of three (3) consecutive groups of 200 targets at a lower grade percentage, to be downgraded, but handicaps will be adjusted every 200 targets. All scores after the last grading must be carried forward onto the new ACTA Record Card.

AA Grade 97% and over – Handicap 0; A Grade 94% and under 97% – Handicap 1; B Grade 90% and under 94% – Handicap 2, 87% and under 90% – Handicap 3; C Grade 82% and under 87% – Handicap 4 under 82% – Handicap 5.

*Note: Club Managements have the option of shooting D Grade under 80% – Handicap 6.*

- (c) All wins shall be recorded with a OW (overall) or GW (grade) beside scores on ACTA Record Cards.
- (d) No shooter shall have a handicap greater than 5 except when Club Management programs D Grade (handicap 6) and then for that event only.
- (e) All targets are to be recorded and used for handicapping/grading (championship events, handicap events and any shoot-off). It shall be the responsibility of the designated club official to progressively mark the shooter's ACTA Record Card and after each 200 targets to calculate his new handicap/grade. If the 200 targets fall during an event or shoot-off, regrading will not take place until the completion

of that event. All targets to the end of that event and shoot-off targets are to be used in calculation of percentage, except the last target missed in any shoot-off, which will not be recorded. Re-grading and re-handicapping shall not take effect until the end of a day's shooting.

### 6.03 ADJUSTMENTS

- (a) Club Management and Secretaries are instructed that at the end of a day the Management must immediately re-grade and re-handicap each and every shooter who for any of the reasons prescribed in the Handicapping Formula qualified for any movement of his grade and handicap. Such adjustments are to strictly conform with the handicapping formula. No shooter is to be permitted to compete in another event should he refuse to accept his new grade and handicap.
- (b) If some clerical error appears on a shooters ACTA Record Card, it is the shooter's responsibility to have the mistake corrected and to shoot off the correct handicap mark.
- (c) Errors and/or amendments may be corrected by the Club Secretary, a member of the Executive Committee of the ACTA, Rule Supervisors or the State Handicapper.
- (d) Correction to errors and amendments must be ruled out and signed with the correction or amendment clearly visible. Correction fluid or the likes of are not permitted to be used.
- (e) It is the shooters responsibility to ensure that all scores have been entered correctly, and progressively totalled.
- (f) Any change to a shooters grade or handicap must be entered into the ACTA database by a designated club official. All changes to a shooters grade or handicap must be entered into the database within five (5) working days.
- (g) Club Management, Rule Supervisors, State or Zone Handicappers or a member of the ACTA Executive Committee have the right to re-handicap or re-grade any obviously under-handicapped or over-handicapped, under-graded or over-graded shooter immediately. The Association is to be notified within 14 days with the reason given on a handicap return form.
- (h) In determining a shooters grade an official may disregard any scores obviously not indicative of the shooters ability.
- (i) ACTA Record Cards may carry a signed directive by a State or Zone Handicapper, Rules Supervisor or ACTA Executive member.
- (j) Should a shooter's ACTA Record Card carry any signed directive, then no person can vary the directive without the prior consent of the State Handicapper through which the shooter is registered, or a member of the ACTA Executive Committee. Any alteration to the directive must be accompanied by the signature of the respective State Handicapper or ACTA Executive member. It shall be the shooter's responsibility to ensure that any directive is carried over to any new or replacement ACTA Record Card.

# COMPETITION CONDITIONS

## SECTION 7

### **7.01 ENTRANCE FEES**

Entrance fees and trophies for all National Championships to be determined each year by the full Executive Committee.

### **7.02 AUSTRALIAN 12 GAUGE SKEET CHAMPIONSHIP**

To be an event which for the time being shall be shot under conditions as determined by the Executive Committee.

### **7.03 AUSTRALIAN SKEET DOUBLES CHAMPIONSHIP**

To be an event which for the time being shall be shot under conditions as determined by the Executive Committee.

### **7.04 AUSTRALIAN SKEET HANDICAP**

To be an event which for the time being shall be shot under conditions as determined by the Executive Committee.

### **7.05 AUSTRALIAN SUB GAUGE SKEET CHAMPIONSHIPS**

#### **(a) AUSTRALIAN 20 GAUGE**

#### **(b) AUSTRALIAN 28 GAUGE**

#### **(c) AUSTRALIAN 410 GAUGE**

To be an event which for the time being shall be shot under conditions as determined by the Executive Committee.

### **7.06 AUSTRALIAN SKEET CHAMPION OF CHAMPIONS**

To be an event which for the time being shall be shot under conditions as determined by the Executive Committee.

### **7.07 AUSTRALIAN/NEW ZEALAND SKEET TEAMS MATCH (GLENN TROPHY)**

- (a) Selection of the Australian team to compete in New Zealand or Australia will comprise the top 5 scores of the combined Handicap, Commonwealth and National Skeet events comprising 250 targets.
- (b) Both teams will shoot at two rounds of 25 targets per shooter. In the event of tied scores all members of each team shall shoot doubles on each of stations 3, 4, 5, 4, 3, 4, 5 (recurring), with the scores being compared after each station. The team with the fewest "LOST" targets after any station shall be declared the winner.
- (c) Cartridges shall be the prescribed maximum 28-gram shot load as for all Championship series.

### **7.08 COMMONWEALTH EVENTS (Day or Night)**

The Skeet Championships shall be shot as graded events at 100 targets.

### **7.09 STATE EVENTS (Day or Night)**

The Skeet Championships shall be shot as graded events at 50 or 100 targets.

### **7.10 ZONE EVENTS (Day or Night)**

The Skeet Championships shall be shot as **graded events** at 50 or 100 targets.

### **7.11 DISTRICT EVENTS (Day or Night)**

- (a) The Skeet Championships shall be shot at 25 or 50 targets.
- (b) The Skeet Doubles Championship shall be shot at 25 pairs.

### **7.12 SASHES/DONATED TROPHIES**

- (a) Sash colours for clubs to be any colour other than those designated for National, Commonwealth – both royal blue, State – red or alternatively Official State colours.
- (b) In all Championships the Management shall provide a sash or badge for the overall winner.
- (c) In all National, State and Zone Handicap events the Management shall provide a sash or badge for the overall winner.
- (d) Any person/s or organisations may donate a trophy or trophies for competition but must comply with ACTA regulations.

### **7.13 INTERSTATE POSTAL TEAM MATCHES – SKEET**

- (a) Team 15 members. Best 10 scores to count, 50 targets per member, to be shot in two rounds of 25 targets as a separate event. In the event of tie for High Gun, to be shot off squad system, first miss out. Standard load shells not to exceed 28 grams of shot, No. 7 size or smaller. Women, Junior & Veteran teams to be 6 members with 5 best scores to count, 25 targets per member.
- (b) Qualifications: each team member shall have registered in the State which he represents and may only represent one State in any one calendar year. In the event of a tie, to be shoot off squad system, first miss and out.
- (c) State Associations shall select their team on the results of an elimination shoot or series.
- (d) Shooters who qualify to represent more than one team, eg open and juniors, may compete in each match at the discretion of their State Associations. Scores may not be transposed.
- (e) An appropriate High Gun trophy shall be provided and a souvenir badge shall be given to each of the 15 State Team Members. The program and venue of the Interstate Skeet Teams' Match shall be advertised in the ACTA Shooting News prior to the event. The competition to be completed in each State not later than December 31st of each year.
- (f) Only official ACTA Referees to officiate, Scorer and check Scorer to be provided. Score sheets to be signed by Scorers and Referees.

- (g) No other major shoot is permitted in the particular State on the day or days when elimination and State Teams' Shoot is held.
- (h) Results of the competition, which must be completed by December 31, must not be publicised until all teams have contested. These result, including the score sheets signed by both the Referee and Principal Scorer, must be sealed and lodged with the ACTA Executive Director by December 31. A check Scorer should be used at each field. Final details of the Interstate Teams' Matches to be published in the first available ACTA Shooting News.
- (i) Should a tie occur between any of the respective State Skeet Team scores, then the count back system is to be applied to achieve a decision.
- (j) In the event of the competition being suspended, for whatever reason, all targets shot shall count and competition completed as soon as possible, commencing from where the competition was suspended. (Refer Rule 8.15)

#### **7.14 EVENT TIES**

- (a) All ties shot in championships must be shot off to determine placings. Shoot-offs by regular skeet rounds as per round procedure (re: Rule 5.11) shall be miss and out by target. After a miss the shooter shall unload and retire from the station and allow following competitors the opportunity to shoot and break the tie. The hierarchy for advancement to the next station is: 1-1, then 1-0, then 0-1, and last 0-0. If all following shooters miss the same target then the first shooter is recalled to shoot the option shot and complete the station if necessary. Doubles shoot-offs shall be miss and out by station. The hierarchy for advancement is: 1-1, then 1-0 or 0-1 (these are equal), and last 0-0. Any number of shooters that Management deems practical may be squadded together for a shoot-off. However when more than one squad participates in a shoot-off, they may commence shooting together on different fields providing Management deems that situation equitable. Pacer for lone participant on a field in a shoot-off shall not be permitted.
- (b) At the discretion of Club Management, shoot-offs may be conducted in conjunction with following events or as doubles from Stations 1 to 7, or as doubles from Stations 3, 4 and 5, or any other format that is mutually agreed between shoot Management and all shooters involved.
- (c) Shoot-off competitors shall carry enough shells for a complete run over a layout. Failure to comply may be grounds for disqualification.
- (d) Competitors are allowed five (5) minutes to replenish ammunition between rounds of shoot-off. Failure to comply "lost target".
- (e) Doubles shoot-offs shall be conducted from doubles stations 3-4-5, miss and out by station. This means that a shooter must break both

targets on a station in order to beat a shooter who only broke one target (ie, if one shooter breaks the first target and another shooter breaks the second target, they are still tied).

- (f) Should a gun malfunction occur during a shoot-off, the competitor has ten (10) minutes to repair or replace the gun. Failure to comply means “lost target”.
- (g) If shooters involved in a shoot-off offer Management a mutually agreed upon method of determining the places, Management may accept. If Management does not accept, shoot-offs must continue and any shooter who refuses to continue forfeits.

## **7.15 HIGH GUN**

- (a) High Gun Shoot-offs at Nationals will be shot off with the smallest gauge in program and shall comprise of targets from 2, 4 & 6 (normal skeet, consisting of 10 targets in all), and one pair of doubles from stations 3 & 5, totalling 14 targets in all. The targets shall be shot on the stations in normal numerical sequence and the result shall be determined by total score to count, continuing until a result is achieved.
- (b) When Skeet or ISSF Skeet is included in a high gun over a trap shooting program, the High Gun Shoot-Off shall include a high and low target from station four. When Skeet Doubles are included over a program, the High Gun Shoot-off shall include a double from station four with shooting continuing in brackets of two targets from each type of event until a result is achieved.
- (c) **At National and State Events, Section High Guns will be awarded to the highest scoring shooter in that section**
- (d) When graded High Guns are awarded over a program, each competitor will remain in the grade first nominated in, even if his grade or handicap changes during the program
- (e) When multi-disciplines high guns are shot, they will be that of the discipline of the highest grade. For example, B grade Trap, AA grade Skeet, C grade ISSF Trap – High Gun grade AA as in Skeet

## **7.16 STATE SHOULDER TO SHOULDER TEAM MATCHES – SKEET**

- (a) Teams shall comprise – Open 5 persons, Ladies 3, Juniors 3 and Veterans 3.
- (b) Open teams will shoot at 2 rounds (50 targets), Women, Junior and Veteran teams will shoot 1 round (25 targets).
- (c) **Qualifications: each team member shall have registered in the State the member represents and may only represent one State in any one calendar year.**
- (d) **State Associations shall select their team on the results of an elimination shoot or series (State Carnivals).**

- (e) Shooters who qualify to represent more than one team, eg Open and Juniors, may compete in more than one team, if compliant with ACTA competition conditions.

## **ADMINISTRATION**

### SECTION 8

#### **8.01 FIELD LAYOUT**

- (a) A skeet field shall consist of eight shooting stations arranged on a segment of a circle of 19.2 metres radius, with a base chord 36.8 metres long, drawn 5.49 metres from the centre of the circle. The centre of the circle is known as the target crossing point and is indicated by a marker.
- (b) Station 1 is located at the left end of the base chord, and station 7 at the right end when facing the centre while standing on the periphery of the segment. Stations 2 to 6 inclusive, are located on the periphery at points equal distant from each other (the exact distance between stations 1 and 2, 2 and 3, etc is 8.14 metres). Station 8 is located at the centre of the base chord.
- (c) Shooting stations one and seven are a square area 900 mm on a side with two sides parallel to the base chord. Shooting stations two to six inclusive, are a square area 900 mm on a side, with two sides parallel to a radius of the circle drawn through the station marker. Shooting station eight is a rectangular area 900 mm wide by 1800 mm long, with the long sides parallel to the base chord. The location of each shooting station shall be accurately designated. For shooting stations one to seven it is in the centre of the nearest side to the target crossing point, of a suitable pad 900 mm square with the front edge on the periphery of the circle. However, the pad for shooting station eight is placed lengthwise on the centre point of the base chord and is 900 mm by 1800 mm. The centre of station eight is on a line drawn between the centres of stations one and seven. The designated shooting station for each house, is the half of the rectangular pad, most distant from the respective house.

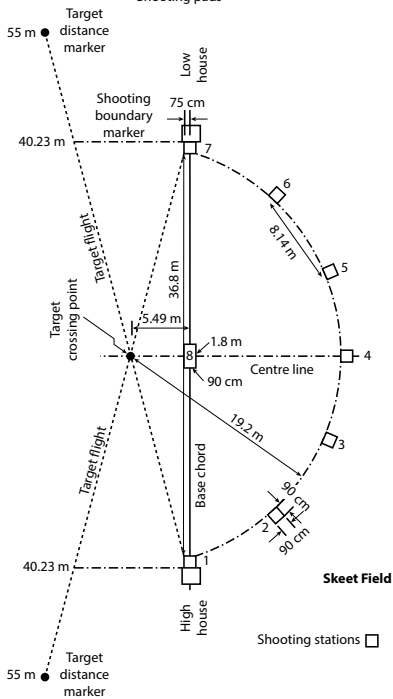
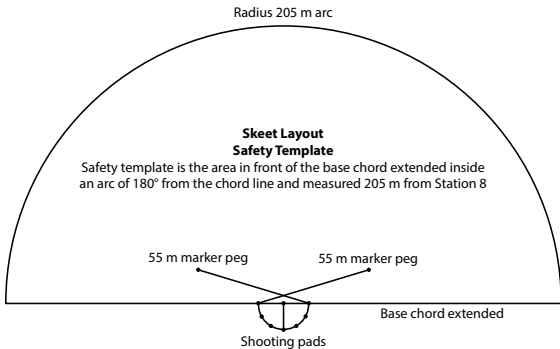



- (d) A shield must be installed at the target opening of each traphouse, so that the trap operator is not visible to the shooter when he is firing from any station. This precaution is required as a safety factor for the protection of the trap operator from possible injury from direct or ricocheting shot. **Targets chutes on new skeet layouts as of 1 January 2020 must comply to ACTA dimensions. Refer ACTA for diagrams schematics.**
- (e) One target should emerge from a traphouse (called high house) at a point 90 centimetres beyond the front of pad one (measured along the base chord extended) and 3.05 metres above ground level. The other should emerge from a traphouse (called low house) at a point 90 centimetres beyond the front of pad seven (measured along the base chord extended) and 75 centimetres from the base chord extended (measured on side of target crossing point) and 1.07 metres above the ground.
- (f) Suitable markers shall be placed at points 40.23 metres and 55 metres from both the high and low house measured along the flight of a regular target. The first marker shall indicate the shooting boundary limit and the second marker shall indicated the minimum distance a target shall travel in still air.
- (g) The target crossing point must be marked in a visible manner where geographically possible.
- (h) It is recommended and desirable that the side of the trap house, from the bottom of the chute to the top of the house, be a very light colour or painted white where feasible.
- (i) As a safety precaution, safety fences should be erected running at right angles to the base chord from both the high and low trap houses to at least level with No. 4 Station. (Grounds should meet State safety requirements.)

## 8.02 SHOOTING BOUNDS

For Stations 1 to 7 inclusive, to be an area 40.23 metres in front of the traphouse from which the target is released. These bounds must be clearly marked on the skeet field with a suitable marker (see field layout). For No. 8 Station, to be from the traphouse from whence the target is released to a point defined on the field layout as the centre line.

## 8.03 TRAP HOUSES

Trap houses shall be used to give full protection to the trappers.

## 8.04 LEGAL TARGET

- (a) Is released “instantly” in response to the competitor’s acceptable call. It may be released by the puller, who must be either the Referee or an authorised target release operator appointed by shoot Management. Or it may be released by voice activated electronic equipment, provided that equipment incorporates a delay mechanism that is

## High and Low House Window Placements

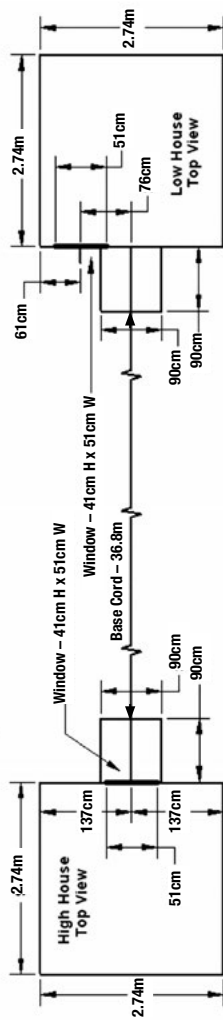

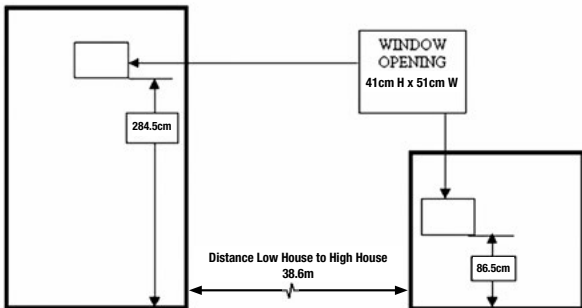

timed to imitate the biological reaction time of a human puller. This delay time is necessary to allow equitable integration between events using pullers, and events using phono-pulls.

- (b) Passes within 45 centimetres horizontally or vertically of a point 4.57 metres above the target crossing point. For this purpose a target setting hoop should be used. Such hoop is 90 cm in diameter and mounted on a 4.12 metre long pole.
- (c) In still air, when passing through the centre of the target setting hoop, must carry to a distance equivalent on level ground to 55 metres with an allowable tolerance of plus or minus two metres.

### 8.05 REGULAR DOUBLE

Two legal targets released simultaneously (one from each traphouse). Proof double, two legal targets released simultaneously (one from each traphouse) to establish a result not yet determined.

### 8.06 TARGETS

Targets shall measure not more than 11 centimetres in diameter not more than 2.85 centimetres in height nor more than 110 grams in weight.

### 8.07 TRAPS

In all open events any trap which throws a legal target may be used, provided the target is released from a position in the field by mechanical or electrical device (NOT released from within the traphouse).

Automatic traps are strongly recommended for all disciplines.

### 8.08 FIREARMS

- (a) The term "Magazine gun" applies alike to self loading or pump action firearms and other firearms not directly dependent on hand loading and are permissible for clay target shooting.

- (b) Release trigger firearms shall only be used on registered ACTA ground, subject to the following conditions:
  - (i) ACTA shooters wishing to use a release trigger shall make application to a Rules Supervisor for approval. The Rules Supervisor shall, by whatever means he determines, have the applicant examined on his understanding of the use of a release trigger device. Where a Rule Supervisor has satisfied himself that the applicant understands the use of a Release Trigger device the shooter shall be included on the master register of release trigger users and his ACTA Record Card shall be marked accordingly by the ACTA.
  - (ii) No ACTA shooter other than those authorised by these rules shall use a release trigger firearm.
  - (iii) All release trigger firearms used by ACTA shooters and overseas visitors shall be clearly labelled in a conspicuous place near the breech.
  - (iv) Release trigger firearms shall not be left in gun racks or in positions where they can be handled but shall be constantly under the control and supervision of the user.
- (c) No firearm which has a gauge larger than 12 gauge is permitted nor shall any barrel(s) length be shorter than 63 centimetres overall.
- (d) The use and carriage of military style shotguns is prohibited on ACTA grounds at all times. Military style firearms are those which could include: forward pistol grips, collapsible or folding stocks, detachable magazines, barrel shrouds or flash suppressors. On application to a Rules Supervisor an exception can be made to a standard competition gun fitted with a pistol grip for a person with a handicap requiring such a grip.
- (e) A maximum of two cartridges are allowed in any gun at any one time
- (f) No sighting devices other than conventional sights shall be permitted. Any device fitted to a gun that has magnifying, light emitting, forward lead displacement properties, or that give visual enhancement of the target are prohibited.

## **8.09 CARTRIDGES**

- (a) For all 12 gauge events (Commonwealth, State, Zone, District, Club) The load is limited to 28 gram struck measure or equivalent shot size not larger than no. 7. Reloads are permitted in all events including National Championships.
- (b) Twenty gauge events shall be open to all guns of 20 gauge or smaller using shot loads limited to 24 gram struck measure of shot size not larger than no 7.
- (c) Twenty eight gauge events shall be open to all guns of 28 gauge or smaller using shot loads limited to 21 gram struck measure of shot size not larger than no 7.

- (d) 410 bore events shall be open to all guns of 410 bore or smaller using shot loads limited to 14 gram struck measure of shot size not larger than no 7.
- (e) A gun of larger gauge, which has been converted to take a smaller gauge shell, may be used in an event for which it has been converted provided that the shell itself complies with the rule requirements for that event.

## **8.10 COMPETITOR AND COMPETITION**

Wheresoever the word “Competition” may be used in the following rules, it is to be understood to refer to each particular event, and must at all times be construed by the Management in whose charge the carrying out of such “Competition” has been entrusted.

- (a) Open Shoots, that is Commonwealth, State and District Championships and open competitions must have the approval of the State Association before being advertised or conducted. (This rule applies to the actual event and the proposed date of holding.)
- (b) Clubs allocated Commonwealth Championships and Interstate Teams’ Matches must advertise the event in ACTA Shooting News prior to the actual shooting date.
- (c) Clubs allocated State Championships must advertise these events in the ACTA Shooting News.
- (d) A competitor is one who has nominated for a particular event and whose name appears on the official score sheets or scoreboard. A competitor can participate only once in each event. Each competitor shall carry and present his current ACTA Record Card at all shoots.
- (e) Every competitor entering competitions agrees to accept all official decisions, and to abide by the rules controlling the competition.
- (f) All competitors must be registered through an affiliated club with the ACTA before taking part in competition. Non ACTA shooters are not permitted to compete at any time.
- (g) Competitors must at all times use their correct names when entering a competition. Shooting nom-de-plumes are not permitted.
- (h) Any competitor who commences an event and withdraws, or is disqualified from the competition, forfeits the right to resume and to any refund from the event.
- (i) Non resident shooters shall be granted reciprocal rights if able to produce evidence of their membership of a similar international clay target shooting organisation. Their grade shall be determined by their current percentage.

## **8.11 AGE ELIGIBILITY FOR COMPETITION**

- (a) Junior category to be under the age of 18 years on the date of competition.

- (b) Sub-Junior category be under the age of 15 years on the date of competition  
(Minimum participation age shall be subject to State Law.)
- (c) Veteran category to be a minimum of 65 years of age on the date of competition.

## **8.12 CATCHING UP**

- (a) Practice is permissible on all occasions that an official practice field is operating.
- (b) Where a shooter has registered in a event, but does not show up to start the event with his squad, he will not be permitted to shoot up after the first man in the squad has fired a shot at Station 2. He may join the squad for all later rounds, but the round missed because of lateness must be shot on the proper field in the first vacancy, or after all other contestants have finished. In the interest of conserving time the shoot Management may modify this rule to meet special conditions, if it so desires.
- (c) Under normal conditions, a squad should complete a round of skeet in 20 minutes. Unusually slow shooting squads who are disrupting the normal sequence cannot object to being transferred to a substitute or practice field.
- (d) Any shooter who, after completing his event, shoots for targets only is deemed ineligible for any recognition in the event or High Gun program.

## **8.13 TARGETS ONLY**

Shooting for targets only, is a term which shall be held to define the status of a competitor in any given event, or events, or in an entire tournament program, and shall signify that a competitor is "shooting for targets only" and has no interest in any trophy or trophies, nor any interest in money or monies in any specific event or events or in the entire program. The competitor's name shall be placed on the squad board, signifying that he is shooting for targets only. "Shooting for targets only" shall be allowed in any event at the discretion of the Club Management.

## **8.14 CHALLENGE**

- (a) At all major competitions a jury shall be appointed. Any appointed jury shall have the authority to supervise the setting of traps and their decision shall be binding.
- (b) A competitor may challenge the load of any other competitor. On receipt of a written challenge, with \$20 forfeit, the Management shall obtain a cartridge from the challengee, and if after examination the Management finds the challengee has violated requirements he may be disqualified providing the offence was wilfully committed. If the challengee is wholly innocent, the forfeit shall be paid to him,

otherwise it shall be returned to the challenger. The Management of any club, or of any tournament has the power to examine any competitor's cartridges at their discretion, without involving themselves in any penalty.

- (c) A competitor may appeal against the decision of a Referee in regard to interpretation and application of these rules. The competitor shall advise the Referee before he leaves the field that he intends to appeal, and immediately upon completing his run over the fields the competitor shall lodge a written appeal and \$20 forfeit with the Management.

## **8.15 MANAGEMENT**

- (a) The Management of any club holding a tournament or competition under these rules, has the authority to reject any entry in the said tournament or competition with good reason, and to disqualify any competitor who acts in an unsportsmanlike or disorderly manner, or who violates safety requirements.
- (b) The Association shall keep a register of shooters. No person may enter or compete at any Association competition or event conducted by a member or members or sub-committee appointed for that purpose, unless such person is registered with the Association as a registered shooter and is not in arrears with his registration fees. The Association shall have the right of refusing to register any person as a registered shooter without giving any reason for such refusal. The registration fee payable by a registered shooter shall be such as the Executive Committee shall from time to time prescribe. The Association shall have the right to de-register any registered shooter for conduct which the Executive Committee decides is unsportsmanlike, or for any breach of the Rules or by-laws of the Association, or for failing to observe the decisions of the Association.
- (c) Should darkness, bad weather, or other cause interfere with the competition, the Management shall have the right to decide when and how the competition shall be completed. If postponed the event must be completed within one calendar month. Any competitor who defaults in respect of such postponed competition forfeits all his rights and standing therein.
- (d) All clay targets broken or otherwise shall remain the property of the club.
- (e) ACTA Record Cards must be produced upon request by either Club Management, Zone or State Handicappers, Rules Supervisors, State Associations and National Executive members of the ACTA. In the event of an investigation by any listed parties they have the right to retain the ACTA Record Card for the period of time necessary to undertake the investigation.

## **8.16 JURY**

- (a) The Management shall appoint a jury of three. The jury shall be appointed from (in order) members of the Executive Rules Sub Committee, Executive Committee, Rules Supervisors, Referee Examiners, Qualified Referees on the grounds, to examine the matter.
- (b) Should the competitor's appeal be upheld, his deposit shall be returned and the correct ruling shall be applied to the target appealed against. Should the appeal be disallowed the deposit shall be forfeited and paid to the club concerned. There shall be no appeal against a Referee's decision in regard to whether a target is legal or whether it has been missed.

## **8.17 REFEREE**

- (a) To become a Registered Referee, a candidate shall approach his Club Secretary and President, who (when they consider that the candidate has achieved a satisfactory standard) shall recommend in writing to the nearest registered Referee Examiner on the prescribed form that the candidate be given a practical and oral examination. When the candidate has passed this examination to the Examiner's entire satisfaction, the Examiner will then submit his recommendation plus the form to the ACTA Executive Director, who will issue a Referee badge to the candidate. Any candidate who has failed and wishes to be re-examined must be re-examined by the same Examiner.
- (b) The Rules Supervisors will keep a record of all Referees in their State.
- (c) The Club Management complaint of any Referee or Referee Examiner shall be referred to the nearest Rules Supervisor within the State for investigation. The Rules Supervisor has the power to suspend the person concerned until the State Association Meeting. If justified, the State Association has the power to further suspend and recall the Referee or Referee Examiner's badge and shall advise the ACTA Executive Director of the action taken.
- (d) Referees shall be appointed for a period of five (5) years and are eligible for re-examination. Any Referee or Referee Examiner who fails to register in any year will have his name automatically removed from the Association Referee and Referee Examiner list.
- (e) The Referee's decision in all cases coming under his jurisdiction as set forth in the rules shall be final. Referees are requested to wear their official badge at all shoots.

## **8.18 DUTIES OF REFEREES**

- (a) The Referee, besides attending to special duties set forth in these rules, shall adjudicate the competition, he shall distinctly and loudly announce the result of each shot by calling out "one" when



the target is broken. He shall decide all other issues which arise in relation to the direct competition.

- (b) A check Referee may be employed, with the Chief Referee to give the decision.
- (c) If the Referee is negligent, or inefficient, impairing thereby the equity of the competition, the Management may forthwith remove him. This rule applies also to Scorers, target release operators, trappers and any other of the staff.
- (d) The Referee is empowered to challenge the ammunition used by any competitor.
- (e) The Referee has power to alter his decision. If altering his decision on “lost target” or “balk” etc, during the competition, this must

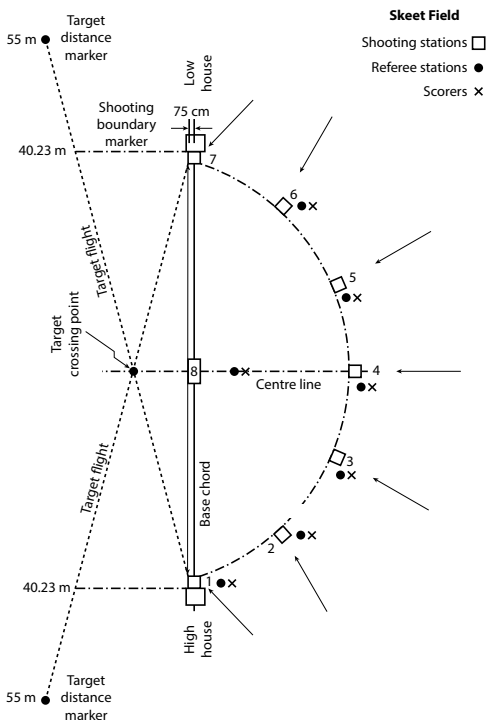

be done before the shooter in question shoots his next target or the shooter leaves the tracks should this be his last target.

- (f) The officiating Referee **MUST** have a trap checked and if required adjusted immediately, if in the opinion of the majority of the competitors in the squad, it is not throwing legal targets. Immediately following such alteration, a target must be thrown and the competition continued. Unauthorised shooters are not to interfere with or attempt to interfere with the setting of the trap. Violation of this rule may be grounds for disqualification from the event.
- (g) He must have complete knowledge of the rules of the ACTA and shall adjudicate the competition at all times as set by the Management.
- (h) It is his responsibility to announce the conditions as set out in the rules for each event before the competition commences, also to deploy shooters in their correct shooting order.
- (i) As shooting proceeds he must observe that shooters do not shoot out of turn, are handling their guns with safety, and using the correct cartridges as laid down for each individual event.
- (j) The Referee must be efficient and alert at all times and it is most important that he should gain the confidence and respect of each and every competitor.

#### **8.19 DUTIES OF A SHOOT MARSHAL**

- (a) He must observe all the duties of the Official Referee.
- (b) He must be present at all shoot-offs.
- (c) He must see that all traps are checked for correct height and angles during competition and prior to shoot-off.
- (d) The Shoot Marshal shall be in charge of all operations and personnel relating to the shoot, and shall be responsible only to the Management. A Shoot Marshall cannot over-rule the Referee's decision (See Rule 8.17)
- (e) He must instruct and roster the duties of all personnel prior to the commencement of each day's shooting.

#### **8.20 DUTIES OF REFEREE EXAMINER**

- (a) To examine applicants for Referee in skeet who have been recommended as required in the ACTA Shooting Rules.
- (b) To assess the applicant's temperament, fairness, his ability to control a situation and his personal behaviour on the shooting grounds as a shooter before considering an examination.
- (c) To observe the actions of existing Referees on the shooting ground and to discuss any problems or make any recommendations considered appropriate.
- (d) To make himself available when convenient to attend rules discussions when required by clubs.

## 8.21 DUTIES OF RULES SUPERVISOR

- (a) A maximum of two suitable qualified persons appointed by the relevant State Association until such time as they may elect to resign or alternatively are replaced by their State Association. Rules Supervisors must be selected from experienced Referee Examiners who have held that position for a minimum of three years.
- (b) To examine applicants theoretically and practically for the position of ACTA Trap, Skeet and Sporting Referee Examiner and to advise the ACTA when the applicant is successful. Also to examine, or arrange for applicants to be theoretically and practically tested for the position of ACTA ISSF Referee Examiner and to advise the ACTA when the applicant is successful. Maximum of one ISSF Referee Examiner per State to be appointed.
- (c) Prior to the applicant attaining the status of Referee Examiner, an applicant must have completed a three year term as an official ACTA Referee.
- (d) To observe the actions of existing Referee Examiners and Referees and to discuss any problems concerning their duties.
- (e) To investigate the written complaint of any Club Management or Referee Examiner concerning the ability of existing Referees and to report to the appropriate State Association when action is considered necessary, with full facts so that the State Association concerned may recommend the action to be taken.
- (f) To investigate the written complaint of any Club Management concerning the ability of any Referee Examiner and to report the facts to the appropriate State Association concerned, so that the State Association concerned may recommend the action to be taken.
- (g) To arrange or require the re-examination of any Referee Examiner or Referee when considered necessary.
- (h) A Rules Supervisor should not generally carry out Referee examinations but may do so if requested or if there is no Referee Examiner in the area.
- (i) To make themselves available when convenient to attend rules discussions when requested by clubs. To make themselves available to attend the Bi-Annual Rules Supervisors meeting.
- (j) To keep an up to date list of current Referees within their State and to arrange for their re-examination prior to the expiry date.
- (k) To investigate any serious breaches of these Shooting Rules when requested in writing by Club Management or individual members, and to provide a written report of the findings (if considered necessary) to the relevant State Association for action.
- (l) To adjudicate on the interpretation of these Shooting Rules within their State when requested by Club Management or individual members.
- (m) To have applicants examined (by any means the Rules Supervisor

determines) on their understanding and safe use of a Release Trigger device before the applicant can use a Release Trigger device at any ACTA affiliated Shooting Ground.

## **8.22 REFEREE AND SCORER**

- (a) The Scorer shall keep an accurate record of each shot, according to the Referee's call. He shall mark the figure 1, or 0 relative to the Referees call. If the Scorer is incompetent at scoring, the Referee has the right to change the Scorer before commencement or during the event.
- (b) All malfunctions, faulty cartridges or misfires must be recorded on the score sheet as "M" for malfunction, "R" for all refusals.
- (c) The official score must be kept on a score sheet and be available for inspection by the competitor.
- (d) It shall be the responsibility of the competitor to check his score with the score sheets before leaving the field. Any protest on his score must be lodged with the Referee immediately, ie before leaving the shooting field. Such protest can only be made against incorrect score.
- (e) The positioning of Referees and Scorers be mandatory in keeping with the positions in the illustrated Skeet Field.  
Note: Scorers to be positioned in immediate proximity of the Referee using the position illustrated in the rulebook for Referees.

## **8.23 BREAK RECOGNITION**

- (a) Break Badges will be recognised in sequences of 50, 75, 100, 150, 200, 250 and so on, provided these are shot in regular competition on one day only, excepting over a program of two or more successive days.
- (b) Clubs must submit form number 17, duly completed, to the ACTA, with the prescribed fee for each requested badge, before recognition can be considered or granted. Break badges, once they have been obtained, will not be repeated.
- (c) Break badges are available for all breaks up to and including the break, in the recognised sequence, as a result of any one break.
- (d) Break recognition and badges shall conform to the break rules above, except that separate breaks will be recognised for regular Skeet in all four gauges, and for Skeet Doubles. Any deviation from a break in progress, such as shooting a different event or changing the format of a shoot-off to make it different from the normal shoot-off format for that event, will neither add to nor terminate a break in progress. Shoot-off targets will only be recognised if they conform to the format of the event except in Doubles Shoot-offs, where doubles at 3, 4 & 5 is the normal shoot-off format, and thus shall be counted in the Doubles break.

## **8.24 LONG BREAK RECORDS**

- (a) By an Australian – may be established either in Australia or overseas providing all criteria are met. These long break records may only be established by an Australian citizen.
- (b) In Australia – may be established by any shooter competing in Australia under ACTA rules. These long break records may only be established in Australia.
- (c) Long break records will only be recognised if shot over an advertised program and the shooter has finished his event.
- (d) Any tournament from club level upwards can be used for the purpose of establishment of long break records.
- (e) Long break records are recognised in the following Disciplines.
  - (i) Skeet
  - (ii) Skeet Doubles
- (f) All applications for recognition of a long break record established in Australia must be accompanied by proper verification and submitted on the official ACTA form (available upon request). All applications for recognition of an Australian record established outside of Australia, besides the verification, must also have proof that all other conditions such as trapsetting were identical to the ACTA regulation standards.
- (g) Once a long break record is established the competitor's name shall be recorded in the appropriate category together with the long break record score. Any competitor who subsequently equals this score shall have his name recorded alongside the current record holder(s). Any competitor who subsequently betters this score shall have his name entered as the record holder together with the new long break record score and the previous holder(s) name(s) and score(s) shall be deleted.
- (h) The National Office shall keep a complete list, both past and present, of record holders and their scores, together with the dates established.
- (i) Any dispute over the recognition of any long break record shall be referred to the Executive Committee, whose decision shall be final.

## **8.25 RULES – OTHER**

Any rules not specifically covered in these rules should be determined by reference to the current NSSA rulebook.



---

# **ACTA 5 STAND SPORTING CLAYS**

---

# GENERAL INDEX — ACTA 5 STAND SPORTING CLAYS

\* MROSC = Mandatory Requirements for Officials, ACTA 5 Stand Sporting Clays, English Sporting and ACTA Sportrap.

- Abide by result MROSC 15(b), 9.11
- ADMINISTRATION/Management 11: 11.01 to 11.21
- Age 11.08
- Alter decision (Referee may) 9.10(d), 11.16(d)
- Ammunition 11.02
  - challenge by Referee 11.16(c)
  - malfunction of 9.11(a)
- Appeal
  - against Referee's decision 11.12(c), 11.14(b)
- Bad weather/Darkness 11.13(c)
- Barrels MROSC 1, 11.02(a)
- Barrel obstruction MROSC 1
- Barrel length 11.02(a)
- Baulk 9.10, 11.16(d)
- Bet
  - not to make 9.02(r)
- Break recognition 11.21
- Broken Target
  - definition 9.05
- Cartridges
  - not to leave in gun MROSC 10, 9.01(g) (l), 9.02(j)
  - when to put in gun 9.01(m), 9.02(m)
- Cash distribution 11.06
- Catching-up 11.09
- Challenge 11.12
- Clerical error on ACTA Record Card 10.01(o)
- COMPETITION RULES SECTION 9: 9.1 to 9.12, 11.07
  - National Titles, 11.04(a)
  - State Titles 11.04(b)
- Competitor
  - competition 11.07(a)
  - disqualified/withdraws 11.07(e)
  - responsibility 11.20(d)
- Darkness
  - bad weather 11.13(c)
- Describe event MROSC 3
- Disorderly manner 11.13(a)
- Disturb member shooting MROSC 13
- Dress 9.02(v)
- Empty shells 9.02(q)
- Event ties 9.12
- Fauna
  - not to shoot 9.01(n)



- Firearms & loads 11.02(a-i)
  - to remain open MROSC 9, 9.01(a) (b) (e) (l)
- Firing point
  - competitor shall close gun 9.02(j)
  - competitor to be at 9.02(g)
  - to be used when two or three competitors 9.03(c)
- Foot violation — competitors 9.02(l), 9.09(d)
- Gauge 9.01(r), 11.02(a)(b)
- Grading Section 10
  - ACTA Record Cards 11.13(e)
  - failure to produce 10.01(h)
  - return to ACTA in 14 days 10.01(s)
- Gun
  - breaks down 9.09(c)
  - not to close until result of previous shot MROSC 9
  - not to open MROSC 12
  - not to open after misfire 9.01(f), 9.09(c)
  - firing 9.01(d)
  - position 9.02(u)
  - release trigger 9.01(h) (s), 11.02(e)
  - sleeve 9.01(b)(q)
  - to be open 9.01(a) (b) (e)
- Handicappers to be appointed 10.01
- Junior 11.08(a)
- Jury 11.12, 11,14
- Loads & firearms 11.02(a-g)
- Malfunction MROSC 12, 9.01(f), 9.07(i), 9.09(e), 9.11, 11.20(b)
- Management Section 11, 11.13(a-e)
  - misleading 10.01(b)
- Misfire 9.01(f), 9.07(h), 9.11(a)(vi), 11.20(b)
- Mobile Phones — not to be audible 9.01(o)
- Names MROSC 1
  - correct names to be used 11.07(d)
- National Championships
  - Sporting Clays 11.04(a)
- No target 9.07(a-c), (d-o)
  - Doubles/proof doubles 9.08
- Orthodox gun position
  - firing of gun 9.01(d)
- Physical disability 9.01(d)
- Pieces of target 9.02(p)

Powder — loads 9.01(i)  
 Practice 9.12(b), 11.10  
 Procedure 9.02  
 Proof Doubles 9.08, 9.09(b), 9.11  
 Pull — calling for target 9.02(h)  
 Reciprocal rights 11.07(f), 11.13(b)  
 Red signal from traphouse MROSC 10, 9.01(g), 9.01(m)  
 Referee 11.15, 11.20  
     — appointment for 5 years 11.15(d)  
     — complaints against 11.15(c)  
     — decision 11.15(e), 11.16(d)  
     — duties of 11.16  
     — examiner — complaints against 11.19(e-g)  
     — examiner — duties of 11.18  
     — how to become one 11.15(a)  
     — may alter decision MROSC 8, 9.10(d)  
     — record to be kept by Rules Sup. 11.15(b)  
     — to call result MROSC 7  
     — to release target immediately MROSC 6  
     — where to stand MROSC 2, 4  
 Referee & Scorer 11.20  
 Refusal rule MROSC 15,  
 Release trigger 9.01(h) (s), 11.02(e)  
 Re-registering 10.01(f)  
 Rules supervisor — duties of 11.19  
  
 Safety 9.01(a) to (s)  
     — catch MROSC 12, 9.07(k), 9.09(b)  
     — rule — breach of MROSC 11,  
  
 Sashes 11.05  
 Score — how to score pairs, broken with 1 shot, 9.08(g)  
 Scorer — where to stand MROSC 4,  
 Scorer & Referee 11.20  
 Shoot Marshall — duties of 11.17  
 Shooting  
     — on grounds — when not to 9.01(c)  
     — range 11.01  
 Shooting station 9.01(l), 9.02(i) (l) (m) (o)  
 Shooting Competition 9: 9.01 to 9.12  
 Signed directive on ACTA Record Card 10.01(u-v)  
 Simultaneous discharge 9.07(i)  
 Squad — shooters to remain as MROSC 16, 9.02(s)  
 Squads 9.03  
 State titles 11.04(b), 11.05(a), 11.06(d)  
 Sun — no baulk 9.10(b)  
 Sweepstakes 11.06  
  
 Target 9.04  
     — broken 9.05

- different colour 9.07(j)
- dusted 9.06
- doubles 9.04(c), 9.08
- illegal MROSC 15
- legal 9.02(d)(t), 9.07(j), 11.16(e)
- lost MROSC 8, 9.09
- no 9.07, 9.08
- only 11.11
- release MROSC 6
- scoring MROSC 7
- to be shown by Management MROSC 5, 9.02(a)
- to be thrown 9.02(b), 9.04(a) (d), 11.16(e)
- trajectory 9.04(d)
- radius to pass through 9.04(e)

Ties 9.12

Traps. 11.03

- adjustment 9.02(t), 9.04(d)(iii), 11.16(e)
- not to interfere with 11.16(e)
- house 11.03
- layout example (see illustration on last page)
- number 11.01(a)
- to be adjusted immediately 9.02(t), 11.16(e)

Undergraded 10.01(s) (t)

Unsportsmanlike — disorderly 9.01(k), 11.13(a) (b)

Unload your guns etc MROSC 17

Unregistered shooters

- not to compete 11.07(c)

Veteran 11.08(c)

# **MANDATORY REQUIREMENTS FOR OFFICIALS, SPORTING CLAYS, ENGLISH SPORTING & SPORTRAP**

Any reference in these rules pertaining to “him” will also mean “her”.

1. Read shooters’ names from squad sheets and ensure competitors are on correct stations. For safety reasons ask all shooters to check for obstructions in barrels.
2. The Referee must be positioned where he has a clear view of targets and competitors. The Referee may move in order to hear the competitors call so as to give all competitors equity of competition.
3. Describe the event and procedure for conduct of the event.
4. The Referee should ask his Scorer to be close enough to him so that the Referee can see the score sheet, and the Scorer can observe the target as a check Referee.
5. Targets and boundary markers are to be shown by Management to all shooters prior to commencement of competition. Refer Rules 9.02(a), 11.01(c)
6. The Referee must at all times ensure that the target is released immediately on the competitor’s call.
7. The Referee must clearly call the result thus: one, lost, no target, as appropriate. Pairs will be scored 1-1 when broken by one shot.
8. Lost targets must be called immediately, and the Referee may change his decision if the target breaks before it hits the ground.
9. The Referee is to see that the next shooter’s gun remains fully open until the result of the previous shot has been called. Refer Rule 9.01(e)
10. At all times ensure that no competitor leaves a cartridge(s) in his gun after a red signal from the traphouse (breakdown etc) and when moving from station to station.
11. The Referee must speak to a shooter immediately on any breach of the safety rules. If the rules of etiquette are broken the Referee should speak to the shooter concerned after the squad has finished, depending on the circumstances.
12. The Referee must not restore a target if the competitor opens his gun after

a malfunction. In the case of a malfunction the Referee shall visually check the safety catch is not in the on position and that the action is closed. He will request the shooter to test fire the gun once only. Under no circumstances will the Referee attempt to test fire the gun.

13. The Referee should be mindful of the rule regarding squad members and spectators disturbing the competitor shooting.
14. A Referee will not call no target to deny a shooter the opportunity to shoot at a whole target unless a safety hazard exists. The shooter is the only person to decide if the target is acceptable to him.
15. Interpretation of refusal rule:
  - (a) A shooter may refuse to shoot at any target which he considers to be illegal.
  - (b) There is no limit to the number of targets the shooter may refuse as long as the Referee agrees with the reasons. Obviously, if too many targets are refused for illegality, the Referee must find the cause, then correct it. If the Referee does not consider that the target refused is illegal, he will ask the shooter why he refused the target. If the Referee is not satisfied with the reason he will tell the shooter. He will also state that any further targets which are refused, and are considered by the Referee to be legal will be scored "Lost Target". If the above situation seems likely to arise, it is preferable that a third party, qualified if possible, adjudicates subsequent refusals. The foregoing procedure in no way discriminates against Referees using their judgement, it is meant to assist in equity of competition. A major point sometimes missed by Referees is that although a shooter may refuse to shoot at an illegal target, he is equally entitled to accept an illegal target. However, if he shoots at and misses an illegal target, the only decision open to the Referee is "Lost Target". Similarly, if he hits it, abide by result.
  - (c) A Referee should not call "No Target" for a fast or slow released target, nor if the target seems to him to be too high, too low or too wide. "No Target" should only be called in the case of a broken target, a pair of targets emerging instead of a single (or vice versa), or where a safety hazard exists.
  - (d) Referees are to ensure that "R" for refusal is entered on Score Sheet. Every refusal must be called either "No Target" or "Lost Target" by the Referee.
16. The Referee is to see that all competitors remain as a squad until the last shooter has finished.
17. At the completion of each visit to a layout the Referee must request competitors to unload their guns and check their scores.

# COMPETITION RULES

## SECTION 9

### 9.01 SAFETY

- (a) All guns must be immediately opened upon removal from a gun rack or car to determine that they are indeed empty.
- (b) All guns carried on or about the shooting ground must be held in a position of safety, with the breech open and unloaded at all times. At no times is a shooter to carry a gun in a gun sleeve. (Refer rule 9.01(q).)
- (c) Shooting on the grounds at any place other than the firing point at legitimate targets only is prohibited except where a pattern plate is installed, and then only with permission of Club Management.
- (d) Firing the gun in any position other than orthodox, ie to the shoulder, is prohibited (with the exception of a physical disability). Any shooter firing a gun from any position other than orthodox will be immediately suspended by the Club Management and reported in writing to the ACTA – a minimum penalty of three months suspension shall apply.
- (e) All guns must remain fully open until the result of the previous target has been called. The shooter must immediately open the gun upon having fired at his target.
- (f) Shooters experiencing a misfire or malfunction must remain with their gun pointed in the direction of the shooting field until the Referee arrives to adjudicate.
- (g) During any event, competitors must remove all cartridges from their guns immediately upon the red signal at the traphouse, or if any official approaches the traphouse concerned.
- (h) Release trigger guns shall not be left in gun racks or in positions where they can be handled, but shall be constantly under the control and supervision of the user and shall be labelled as per Rule 11.02 (e)iv.
- (i) Powder loads for re-loads must not exceed the manufacturer's recommended specification. Shooters exceeding the recommended load shall be deemed to be in breach of the safety regulations.
- (j) Any shooter knowingly breaching any safety rule other than Rule 9.01(d), will be immediately suspended by the Club Management for one (1) calendar month pending an investigation into their actions by the relevant State Association and the ACTA must be notified of all breaches and responses.
- (k) Any shooter committing an unsportsmanlike or unsafe act on the shooting ground shall be liable to suspension or disqualification.
- (l) When shooting, and it is his turn to shoot, the competitor shall stand on the shooting station, load and close his gun. He must open his gun and remove the cartridges before leaving the shooting station.

- (m) When competing, the shooter will not insert a cartridge in his gun until he is on the shooting station. All cartridges must be removed from a gun upon the red signal at any trap house, or if any official approaches the trap houses on that layout.
- (n) Any shooter deliberately firing at any fauna on any shooting ground shall be immediately suspended by the Club Management and shall remain suspended until the incident is dealt with by his State Association.
- (o) Mobile phones or like devices must not be audible during competition.
- (p) Hearing and eye protection is strongly recommended for all ACTA disciplines whilst present at the firing point or trap area.
- (q) Gun sleeves and slings are not permitted to be used.
- (r) A gun must not be used that will accept more than one gauge of cartridge at the same time and a gun must not be loaded with different gauge ammunition.
- (s) A release trigger is not to be set until the gun is mounted to the shoulder. Failure to comply will incur a warning in the first instance and disqualification from the event for a second offence.

## **9.02 PROCEDURE**

- (a) The target sequence will be shown to all shooters prior to commencement of competition only and with any subsequent changes to the target sequence.
- (b) No sighter target will be thrown or shot at prior to competition commencing.
- (c) A round will consist of 25 targets with no more than 10 pairs of doubles per round. Clubs may conduct 100 target events over an uneven number of layouts, eg 3 layouts, shooting more than 5 targets per stand but maintaining that each shooter shoots the same number of targets on each layout.
- (d) A round may include: (1) single targets. (2) simultaneous doubles – where two targets are released simultaneously. (3) pair on report – when the second target can only be released when a shot has been fired at the first target. (4) following pair (rafale) – two single targets released one after the other in rapid succession. Piggy back doubles – or two targets released one on top of the other.
- (e) Two cartridges can be used on each single target, but only two cartridges to be loaded into the gun at the one time.
- (f) The order of shooting targets shall be marked on a board placed in front of each station.
- (g) A competitor must be at the firing point within two minutes of being called. Failing this he may be disqualified, penalised with loss of targets, or be re-squadded at the discretion of the club.
- (h) When at the firing point ready for competition, the competitor shall

- distinctly give the command “pull” or a similar command to the Referee and thereafter the competitor is in the competition.
- (i) A shooter must stand on the station, position himself, load his gun and call for his target within 10 seconds of the result of the preceding target being called by the Referee or after the Referee has given the signal to commence firing or to resume firing. Non compliance will draw a warning from the Referee, subsequent occurrences per event will be penalised one target each.
  - (j) When it is his turn to shoot, a competitor shall close his gun only when at the firing point and facing the traps, he must remove the cartridge or cartridges from his gun before moving from the firing point on each station.
  - (k) The shooter must be ready to commence shooting when called, and must take enough ammunition to complete the round.
  - (l) The competitor must stand with both feet entirely within the boundary of the shooting station.
  - (m) Provided he is standing within the station from where he is going to shoot, a competitor may place cartridges into the breech whilst he is waiting his turn to shoot.
  - (n) Shooters must not close or attempt to mount the gun to the shoulder until the result of the previous shot has been called by the Referee.
  - (o) Competitors in the squad on Stations 1 through 4 will change stations simultaneously on the Referee’s advice. A shooter having fired at his final target on Station 5 may move behind the Referee to take up his position on Station 1.
  - (p) Unless, in the opinion of the Referee, it is contrary to the equity of the competition, a competitor taking part in the competition may shoot at pieces of his own target, if he so wishes.
  - (q) Empty shells on the ground must not be collected whilst shooters are on the shooting ground. Only those people directly associated with the competition will be on the tracks whilst the shoot is in progress.
  - (r) No competitor shall make, negotiate or discuss any bet (either on his own shooting or that of any competitor) whilst he is on the shooting ground. If any competitor infringes this rule, he may be disqualified by the Referee.
  - (s) All members in a squad must remain at their shooting station until the last competitor has shot.
  - (t) The Officiating Referee or the Management must have traps adjusted immediately if they are no longer throwing legal targets. Immediately following such alteration a target must be thrown and the competition continued.
  - (u) Gun Position  
Gun position is optional. When a shooter is ready he will call pull or some word of command. At all stations the gun must be fired from the shoulder.



- (v) All competitors are required to dress in an appropriate manner. The wearing of camouflage clothing (any version), singlets or singlet style sleeveless tops is prohibited. The wearing of thongs, scuffs or bare feet is prohibited. Any shoes worn must have a restraining strap or support at the heel. The wearing of high cut shorts is prohibited.

### 9.03 SQUADS

- (a) The shooting will occur in squads with a maximum of 5 shooters.
- (b) Shooters may shoot for targets only at the discretion of the host club.
- (c) No.1. Shooter will commence at Station No.1, and after each station change he shall continue to commence the shooting on each station. Each station must be completed before moving to the next station, 5 shooters at 5 stations rotate until 25 targets are attempted. For equity of competition split rounds are acceptable over multiple grounds. E.g. Ground 1, two targets per station. Ground 2, three targets per station.

### 9.04 TARGETS

- (a) Regulation skeet or trap targets may be thrown as well as mini, midi, battue, rocket, rabbit or flash targets may also be thrown or any other sporting clay target approved by the association.
- (b) Target type for any stand will be at the discretion of the shoot officials.
- (c) Doubles with Second on Report  
The second target when shooting doubles on report is to be released immediately on report of the first shot.
- (d) Trajectory of Targets
  - (i) At each stand, the trajectories of the targets must be similar in height, angle, distance and speed for all shooters.
  - (ii) At each stand which has targets on report the targets must be thrown in the same order for each shooter.
  - (iii) The traps will not be changed during a round unless the target becomes unreasonable to shoot.
- (e) All targets must pass through, or within a 35 metre radius of the shooting station
- (f) One shot only must be fired at each target of a Double, irrespective of type. Any target of a double shot at deliberately with a second barrel will be declared lost.
- (g) In simultaneous pairs the competitor has the right to shoot either of the targets first. Should the Competitor hit both targets together with either the first or second shot, the result will be scored 1-1. In any regular pair where the competitor having missed the first target fires at the second target and breaks both targets, the result shall be counted as 1-1.

### 9.05 BROKEN TARGETS

A broken target is one which has a visible piece broken from it, whilst in the air, by the shot from the competitor's gun.

### 9.06 DUSTED TARGETS

A "dusted target" is one from which dust is detached by the competitor's shot, but which shows no visible piece broken from it. A dusted target is not a broken target and is a "lost target".

### 9.07 NO TARGETS

After "no target" has been called by the Referee under any of the following conditions it thereafter plays no part in the competition and is irrelevant to it. No target shall be called when a target is refused for the following reasons:

- (a) A target is released without the competitor's call and the target has not been fired at.
- (b) A time interval occurs before or after the competitor's call unless the target is fired at.
- (c) A target does not conform to the definition of a legal target and the target has not been fired at.

*Note: If in the opinion of the Management, an excess of refusals is recorded, the Management has the right to check the shooter, Referee and equipment. If in the opinion of the Referee, legal targets are being refused, the Referee may call "lost target". All refusals must be recorded on the score sheet as "R".*

- (d) A broken target is released.
- (e) In single target shooting, two targets are released at the same time.
- (f) When a competitor shoots out of turn or from the wrong station.
- (g) Two competitors shoot at the same time, at the same target.
- (h) A malfunction occurs in either barrel caused by the competitors gun or misfire of a cartridge due to no neglect on the competitor's part. In the event of a malfunction of the second barrel, the competitor must fire a live cartridge in the general direction of the target, and is permitted to score with the second barrel only. If the competitor accidentally breaks this target with the first barrel, "no target" shall be called and another thrown; if he again breaks this target with the first barrel, "Lost target" will be scored. If in the opinion of the Referee the first shot was fired before the target was visible, "Lost target" shall be scored.
- (i) A simultaneous or near simultaneous discharge occurs, ie, from any cause both barrels are discharged together or nearly together. Simultaneous discharges shall be recorded as a malfunction.
- (j) A different coloured target than being used for the trap is thrown and not fired at. Firing at the target shall cause it to be considered a legal target with the result to stand.

- (k) No target shall be allowed for the first target of any visit to a layout if a safety catch is engaged.
- (l) If a target is released from the incorrect trap.
- (m) If two targets are thrown simultaneously, when a single should have been thrown or vice versa.
- (n) In a simultaneous double, either from a single or from two traps, either target is broken on leaving the trap, a proof pair will be thrown to determine the result of both targets
- (o) In a rafale pair, if either targets are broken on leaving the trap, a proof pair will be thrown to determine the result of both targets.

#### **9.08 NO TARGET - DOUBLES/PROOF DOUBLES**

- (a) If a double is thrown but the targets collide, before the result of the first target is determined, they shall be declared no targets (both) and the result of a proof double shall determine the score of both shots.
- (b) If the first target of a double is thrown irregularly as to deviate from the prescribed line of flight and is not shot at, a proof double shall determine the score for both shots, whether the second target is fired upon or not. The Referee shall be the sole judge of irregularity.
- (c) If the first target of a double is thrown irregularly as to deviate from the prescribed line of flight, and is shot at, the result shall be scored for the first shot, and if the shooter is deprived of a normal second shot the second target only shall be declared no target and a proof double shall be thrown to determine the result of the second shot.
- (d) The first shot is lost and a collision occurs before the result of the second shot is determined, a proof double shall be thrown to determine the result of the second shot.
- (e) The second target collides with fragments of the first target properly broken, before the result of the second shot is determined, a proof double shall be thrown to determine the result of the second shot.
- (f) The result of the first shot is determined, and interference occurs before the second shot is fired, a proof double shall be thrown to determine the result of the second shot.
- (g) Pairs will be scored 1 - 1 when broken by one shot.
- (h) There shall be no penalty for withholding the first shot when either target of a double is irregular. A proof double shall determine the score of both shots thereafter.
- (i) If a double is thrown and an allowable malfunction occurs on the first shot, it shall be declared no target, and the result of a proof double shall determine the score of both shots. If such malfunction is excessive (not allowable) the proof double shall be thrown to determine the result of the second shot only.
- (j) In the event of a malfunction on the second barrel, the Referee shall declare "No target on the second barrel". The result of the first shot

shall stand and a proof pair thrown to determine the result of the second shot only.

- (k) In the case of an malfunction on the second barrel, should such malfunctions be the fourth or subsequent malfunction, the second target shall be scored lost.

*Note: If the shooter shoots at an illegal first target and the second target is legal, he must also shoot the second target. However, a shooter is not required to shoot at an illegal second target even though he shot at the first target which may have been either legal or an illegal target.*

## **9.09 LOST TARGET**

Lost target shall be called when:

- (a) A competitor fails to break a legal target.
- (b) The competitor fails to shoot because his gun is unloaded, or because the safety was faultily adjusted or jarred back, whether from his oversight or not, or because of any other cause chargeable to his oversight or neglect (no target shall be allowed for the first target of any visit to a layout if a safety catch is engaged). Should this happen in a double, the first target only should be declared lost and a proof pair shall be thrown to determine the result of the second shot only. However, a shot shall be fired at each target in the proof pair.
- (c) The competitor has an apparent malfunction and attempts to open the gun before the Referee examines it. The competitor must not turn around and must keep his gun pointed in the direction of the shooting range until the Referee has given his decision. If a competitor's gun breaks down and it is necessary to seek a replacement the competitor is allowed five (5) minutes to do so. If this is not possible the competitor may leave the squad and finish the remaining targets of the round at a time decided by the Management. Should a gun malfunction occur during a shoot-off, the competitor has 10 minutes to repair or replace the gun. Failure to comply "Lost target".
- (d) A foot position violation occurs. The shooter must stand with both feet completely within the designated station.
- (e) The fourth and subsequent malfunction in any one event occurs. However, at the end of each 100 targets in any one event, the malfunctions that have occurred shall be cancelled, and the count shall re-commence from zero.
- (f) A target is dusted.
- (g) A whole target was fired upon and missed.
- (h) An illegal target was fired upon and missed.

## **9.10 BAULK**

- (a) Any extraneous occurrence, which in the opinion of the Referee materially interferes with the equity of the competitor after he calls for his target constitutes a baulk.

- (b) The sun shall not be considered as interference. It must be considered as a normal hazard.
- (c) Under no circumstances will a baulk be granted unless claimed by the competitor immediately it occurs, and/or in the opinion of the Referee, a baulk has occurred, he may restore the competitor's target.
- (d) The Referee has power to alter his decision. This must be done before the shooter in question shoots his next target or the shooter leaves the tracks should this be his last target.

### 9.11 MALFUNCTION

Should there be a faulty cartridge, misfire or malfunction in the first barrel, and the competitor fires the second barrel where possible, the competitor shall abide by the result and shall have no claim to a repeat target for the first barrel.

- (a) The following are considered malfunctions of ammunition:
  - (i) Failure to fire when firing pin indentation is clearly visible;
  - (ii) When only the primer fires – or is missing;
  - (iii) When the powder charge has been omitted;
  - (iv) When the powder charge is not ignited;
  - (v) Components of the load remain in the barrel.
  - (vi) All misfires and malfunctions must be marked on the score sheet as “M”.

If a shooter has a malfunction on the first shot when shooting doubles on report he will be able to repeat the pair of targets.

If the malfunction occurs on the second target, the result of the first shot counts. A proof pair will be thrown to determine the result of the second target.

### 9.12 TIES

- (a) If two or more shooters in an individual event or two or more teams in a teams event have the same score in a competition the shoot off for placing's will be decided by the host club, on not less than ten targets. ***Except at Nationals where 5 pair doubles, total 10 targets shall be shot until a winner is declared.***
- (b) A competitor eligible for a shoot off is not permitted to practice that event between the event and the shoot off. To do so is automatic disqualification.

# GRADING

## SECTION 10

### 10.01 GRADING

Each club must appoint an official to grade shooters, check to see that all scores are entered on ACTA Record Cards and to check that grade changes are recorded on ACTA Record Cards. All appropriate scores shall be recorded for percentage performance classification irrespective of how the event is run.

- (a) Grading Formula
  - (i) Gradings are to be as follows: AA 85% and over, A 75% and under 85%, B 65% and under 75%, C under 65%.
  - (ii) To be decided on a shooters last two hundred (200) targets.
  - (iii) Upgrading will take place every 200 targets. Downgrading every 600 targets. All completed rounds of 25 including shoot offs will be used. **No re-grading will apply until the end of the club's programme of that day. Should a shooter shoot at another Club later on that day the new grade will take effect.**
- (b) Should it be found that the shooter has claimed the wrong grade, the Club shall advise the State Association so that the matter may be investigated. If it is determined that the shooter deliberately misled the Club Management regarding his grade, the shooter will be suspended for three (3) months.
- (c) A shooter must not shoot in a grade higher than his best performance. Once having attained a grade he may elect to remain in that higher grade when due for regrading. If he so elects he must remain in that grade for the next three groups of 200 targets. If the shooter so elects his ACTA Record Card must be marked to indicate such. Eg: Prefer A grade.
- (d) Managements shall provide a minimum of one prize or trophy for each grade.
- (e) All wins shall be recorded with a OW (overall) or GW (grade) beside scores on ACTA Record Card.
- (f)
  - (i) New shooters without prior competitive shotgun experience will be placed in C grade by the Club for the first 50 competition targets. At the completion of these first 50 targets they will be given a provisional grade and the targets shot will become part of the first 200 targets for grading purposes.
  - (ii) Shooters re-registering after an absence will be placed in the grade in which they left the ACTA for the first 50 competition targets. At the completion of these first 50 targets they will be given a provisional grade and the targets shot will become part of the first 200 targets for grading purposes.
  - (iii) Shooters registering with experience in another shotgun code (eg Field & Game) will be placed in the same grade as their current grade in that code for the first 50 competition targets.

- At the completion of these first 50 targets they will be given a provisional grade and the targets shot will become part of the first 200 targets for grading purposes.
- (iv) Shooters re-registering after an absence who have subsequently been shooting competition in other shotgun codes will be placed in the same grade as their current grade in that code for the first 50 competition targets. At the completion of these first 50 targets they will be given a provisional grade and the targets shot will become part of the first 200 targets for grading purposes.
  - (v) Shooters when first competing in any ACTA discipline who already have any existing ACTA grade will be placed in the highest grade and handicap achieved at any other ACTA discipline for the first 50 competition targets. At the completion of these first 50 targets they will be given a provisional grade and the targets shot will become part of the first 200 targets for grading purposes.
  - (vi) In each of the above 4 circumstances where an event/events progress past the first 50 targets the shooter will be graded on these event targets, they will be given a provisional grade and the targets shot will become part of the first 200 targets for grading purposes.
- (g) Upgrading of shooters after the initial 200 targets is limited to one grade at a time.
  - (h) Shooters failing to produce their ACTA Record Card or an appropriate ACTA Record Card from another ACTA accepted discipline at competition shoots shall pay a \$20.00 penalty fee to the club.
  - (i) Club Managements have the option of running sporting events OA,AA,A,B,C; AA,A,B,C; First, Second, Third; or by combining. AA & A or A & B or B & C grades.
  - (j) It shall be the responsibility of a designated club official to enter individual event scores and progressively mark the shooter's ACTA Record Card. After each 200 targets regrade the shooter if necessary. If the 200 targets fall during an event or shoot-off, regrading will not take place until the completion of that event. All targets to the end of that event and shoot-off targets are to be used in calculation of percentage. The last target missed in any shoot-off will not be recorded.
  - (k) A shooter must shoot a minimum of three (3) consecutive groups of 200 targets, ie 600 targets, at a lower grade percentage to be down graded. Other than in the authority vested in Rule 10.01(t). Once attaining A grade a shooter cannot be regraded to C grade and once attaining AA grade a shooter cannot be regraded to B grade, other than in the authority vested in Rule 10.01(t). A shooter can only be

- downgraded one grade at a time. All scores after the last grading must be carried forward onto a new ACTA Record Card
- (l) Shooters awaiting the issue of a ACTA Record Card after registering for the first time shall be allowed to enter in any competition. Scores shot during this period must be kept and entered on his ACTA Record Card when received.
  - (m) If a shooter has misplaced or lost his ACTA Record Card he shall be allowed to compete providing he is registered with the ACTA or another ACTA accepted discipline. He shall be allowed to compete in his grade. Should he win prize money or trophies they must be retained by the club until such time as the shooter presents his ACTA Record Card to the club for marking.
  - (n) If some clerical error appears on a shooters ACTA Record Card, it is the shooter's responsibility to have the mistake corrected and to shoot in the correct grade.
  - (o) Errors and/or amendments may be corrected by the Club Secretary, a member of the Executive Committee of the ACTA, Rule Supervisors or the State Handicapper.
  - (p) Correction to errors and amendments must be ruled out and signed with the correction or amendment clearly visible. Correction fluid or the likes of are not permitted to be used.
  - (q) It is the shooters responsibility to ensure that all scores have been entered correctly, and progressively totalled.
  - (r) Any change to a shooters grade must be entered into the ACTA database by a designated club official. All changes to a shooters grade must be entered into the database within five (5) working days.
  - (s) Club Management, Rule Supervisors, State or Zone Handicappers or a member of the ACTA Executive Committee have the right to re-grade any obviously under-graded or over-graded shooter immediately. The Association is to be notified within 14 days with the reason given on a grading return form.
  - (t) In determining a shooters grade an official may disregard any scores obviously not indicative of the shooters ability.
  - (u) ACTA Record Cards may carry a signed directive by a State or Zone Handicapper, or Rules Supervisor, or ACTA Executive Member.
  - (v) Should a shooter's ACTA Record Card carry any signed directive, then no person can vary the directive without the prior consent of the State Handicapper through which the shooter is registered, or ACTA Executive Member. Any alteration to the directive must be accompanied by the signature of the respective State Handicapper or Executive Member. It shall be the shooter's responsibility to ensure that any directive is carried over to any new or replacement ACTA Record Card.



# ADMINISTRATION/MANAGEMENT

## SECTION 11

### 11.01 SHOOTING RANGE AND GROUNDS

- (a) Following the configuration of the grounds, a sporting clays range must be equipped with a sufficient number of traps so that the competitor will shoot under conditions as near as possible to field shooting.
- (b) In order to simulate the above, targets shall be thrown at various speeds, singles or doubles, from in front or from behind, low or high, straight away, crossing, quartering or incoming, from either side.
- (c) When setting up a sporting clay course, the club concerned must make sure that traps and boundary markers are positioned in such a way that they afford maximum safety, to the trapper, shooters and also any spectators. A penalty of one target can be imposed by Club Management upon any shooter failing to observe the boundary markers when upon the shooting mark. Guns are not to be taken past the boundary markers when shooting.
- (d) The shooting station is defined as a caged area (1 square metre) from where the shooter will shoot his target or targets.
- (e) All stands are to have muzzle restraints to limit the arc of fire to safe areas.

### 11.02 FIREARMS AND CARTRIDGES

- (a) All smooth bore shotguns are allowed providing their gauge does not exceed 12 gauge and their barrel length is not less than 63cm overall.
- (b) No additional advantage will be given to shooters using guns of gauge smaller than 12 gauge.
- (c) Straps or slings must be removed before competing.
- (d) The term "Magazine gun" applies alike to self loading or pump action firearms and other firearms not directly dependent on hand loading and are permissible for clay target shooting.
- (e) Release trigger firearms shall only be used on registered ACTA ground, subject to the following conditions:
  - (i) Shooters wishing to use a release trigger shall make application to a Rules Supervisor for approval. The Rules Supervisor shall, by whatever means he determines, have the applicant examined on his understanding of the use of a release trigger device. Where a Rule Supervisor has satisfied himself that the applicant understands the use of a Release Trigger device the shooter shall be included on the master register of release trigger users and his ACTA Record Card shall be marked accordingly by the ACTA.
  - (ii) No shooter other than those authorised by this rule shall use a release trigger firearm.

- (iii) All release trigger firearms used by shooters shall be clearly labelled in a conspicuous place near the breech.
- (iv) Release trigger firearms shall not be left in gun racks or in positions where they can be handled but shall be constantly under the control and supervision of the user.
- (f) Ammunition to be any commercially available load or its equivalent in hand load not larger than No.6, and be not greater than 32g struck measure or equivalent.
- (g) A maximum of two cartridges are allowed in any gun at any one time.
- (h) The use and carriage of military style shotguns is prohibited on ACTA grounds at all times. Military style firearms are those which could include: forward pistol grips, collapsible or folding stocks, detachable magazines, barrel shrouds or flash suppressors. On application to a Rules Supervisor an exception can be made to a standard competition gun fitted with a pistol grip for a person with a handicap requiring such a grip.
- (i) No sighting devices other than conventional sights shall be permitted. Any device fitted to a gun that has magnifying, light emitting, forward lead displacement properties, or that give visual enhancement of the target are prohibited.

### 11.03 TRAP HOUSES AND TRAPS

Trap houses shall be constructed and used to give full protection to the trappers.

- (a) Targets will be propelled by, and launched from any mechanical device which can achieve the desired trajectory and speed, using approved targets. Release may be by any means capable of producing the required release.
- (b) Devices which propel more than one target are acceptable.
- (c) Devices propelling targets of more than one type, and devices capable of providing targets at varying angles may be employed, but only in such a fashion that all targets presented are the same for all shooters. Hand throwers are prohibited.

### 11.04 TITLES

- (a) National Titles shall be a **graded event**, minimum of 150 targets. Two days may be taken to conduct this event.
- (b) State Titles shall be a **graded event**, minimum of 75 targets.
- (c) **At National and State Events, Section High Guns will be awarded to the highest scoring shooter in that section**

### 11.05 SASHES/DONATED TROPHIES

- (a) Sash colours for clubs to be any colour other than those designated for National, Commonwealth – both royal blue, State – red or alternatively Official State colours.

- (b) In all Championships the Management shall provide a sash or badge for the overall winner.
- (c) Any person/s or organisations may donate a trophy or trophies for competition but must comply with ACTA regulations.

#### **11.06 SWEEPSTAKES DEDUCTION AND CASH DISTRIBUTION**

- (a) Clubs have the option of taking 60% in cash divide events.
- (b) No deduction is permitted by clubs in optional sweepstakes.
- (c) In all sweepstakes, distribution shall be on the basis of 60% (1st), 30% (2nd), 10% (3rd). A competitor scoring the only possible in the event wins only 60% (1st place). All optional sweeps shall be compulsory division as in the above formula. The Management shall clearly indicate on the official score sheet or scoreboard those who have entered for the optional sweep. When running Graded Sweeps/Cash divide each grade monies to be divided between that grade.
- (d) Sweepstakes at State Carnivals or Championships may be decided by the State concerned. State Associations shall have the option of conducting either compulsory or optional sweepstakes at State Carnivals.

*Note: In all events for cash prizes or trophies excluding sweepstakes, trophies and placing's shall be decided by shoot-off.*

- (e) The inclusion of either compulsory or optional sweepstakes at National Championships and their method of division to be at the discretion of the Executive Committee. Sweepstakes at any competition shall be determined by scores off the gun and shootoffs shall not apply.

#### **11.07 COMPETITOR AND COMPETITION**

Wheresoever the word "Competition" may be used in the following rules, it is to be understood to refer to each particular event, and must at all times be construed by the Management in whose charge the carrying out of such "Competition" has been entrusted.

- (a) A competitor is one who has nominated for a particular event and whose name appears on the official score sheets or scoreboard. A competitor can participate only once in each event. Each competitor shall carry and present his current ACTA Record Card at all shoots.
- (b) Every competitor entering competitions agrees to accept all official decisions, and to abide by the rules controlling the competition.
- (c) All competitors must be registered through an affiliated club with the ACTA or an ACTA accepted discipline before taking part in competition. Unregistered competitors are not permitted to compete at any time.
- (d) Competitors must at all times use their correct names when entering a competition. Shooting nom-de-plumes are not permitted.

- (e) Any competitor who commences an event and withdraws, or is disqualified from the competition, forfeits the right to resume and to any refund from the event.
- (f) Non resident shooters shall be granted reciprocal rights if able to produce evidence of their membership of a similar international clay target shooting organisation. Their grade shall be determined by their current percentage.
- (g) All competitors are required to dress in an appropriate manner with the wearing of singlets and thongs/scuffs prohibited. Shoes must have a restraining strap or full support at the heel. This applies when competing and when they are to be presented with any prize or trophy.

### **11.08 AGE ELIGIBILITY FOR COMPETITION**

- (a) Junior category to be under the age of 18 years on the date of competition.
- (b) Sub-Junior category be under the age of 15 years on the date of competition.  
(Minimum participation age shall be subject to State Law.)
- (c) Veteran category to be a minimum of 65 years of age on the date of competition.

### **11.09 CATCHING UP**

No shooter may be allowed to enter an event after the commencement of the second round of that event.

### **11.10 PRACTICE**

Practice will not be allowed over any competition layout(s) prior to or during competition. Practice may be allowed over any trap(s) not used in the competition layout.

### **11.11 TARGETS ONLY**

Shooting for targets only, is a term which shall be held to define the status of a competitor in any given event, or events, or in an entire tournament program, and shall signify that a competitor is “shooting for targets only” and has no interest in any trophy or trophies, nor any interest in money or monies in any specific event or events or in the entire program. The competitor’s name shall be placed on the squad board, signifying that he is shooting for targets only. “Shooting for targets only” shall be allowed in any event at the discretion of the Club Management.

### **11.12 CHALLENGE**

- (a) At all major competitions a jury shall be appointed. Any appointed jury shall have the authority to supervise the setting of traps and their decision shall be binding.

- (b) A competitor may challenge the load of any other competitor. On receipt of a written challenge, with \$20 forfeit, the Management shall obtain a cartridge from the challengee, and if after examination the Management finds the challengee has violated requirements he may be disqualified providing the offence was wilfully committed. If the challengee is wholly innocent, the forfeit shall be paid to him, otherwise it shall be returned to the challenger. The Management of any club, or of any tournament has the power to examine any competitor's cartridges at their discretion, without involving themselves in any penalty.
- (c) A competitor may appeal against the decision of a Referee in regard to interpretation and application of these rules. The competitor shall advise the Referee before he leaves the shooting ground that he intends to appeal, and immediately upon completing his run over the shooting ground the competitor shall lodge a written appeal and \$20 forfeit with the Management.

### **11.13 MANAGEMENT**

- (a) The Management of any club holding a tournament or competition under these rules, has the authority to reject any entry in the said tournament or competition with good reason, and to disqualify any competitor who acts in an unsportsmanlike or disorderly manner, or who violates safety requirements.
- (b) The Association shall keep a register of shooters. No person may enter or compete at any Association competition or event conducted by a member or members or sub-committee appointed for that purpose, unless such person is registered with the Association as a registered shooter and is not in arrears with his registration fees or is a member of another discipline accepted by the ACTA as having reciprocal rights. The Association shall have the right of refusing to register any person as a registered shooter without giving any reason for such refusal. The registration fee payable by a registered shooter shall be such as the Executive Committee shall from time to time prescribe. The Association shall have the right to de-register any registered shooter for conduct which the Executive Committee decides is unsportsmanlike, or for any breach of the Rules or by-laws of the Association, or for failing to observe the decisions of the Association.
- (c) Should darkness, bad weather, or other cause interfere with the competition, the Management shall have the right to decide when and how the competition shall be completed. If postponed the event must be completed within one calendar month. Any competitor who defaults in respect of such postponed competition forfeits all his rights and standing therein.
- (d) All clay targets broken or otherwise shall remain the property of the club.

- (e) ACTA Record Cards must be produced upon request by either Club Management, Zone or State Handicappers, Rules Supervisors, State Associations and National Executive members of the ACTA. In the event of an investigation by any listed parties they have the right to retain the ACTA Record Card for the period of time necessary to undertake the investigation.

#### **11.14 JURY**

- (a) The Management shall appoint a jury of three. The jury shall be appointed from (in order) members of the Executive Rules Sub Committee, Executive Committee, Rules Supervisors, Referee Examiners, Qualified Referees on the grounds, to examine the matter.
- (b) Should the competitor's appeal be upheld, his deposit shall be returned and the correct ruling shall be applied to the target appealed against. Should the appeal be disallowed the deposit shall be forfeited and paid to the club concerned. There shall be no appeal against a Referee's decision in regard to whether a target is legal or whether it has been missed.

#### **11.15 REFEREE**

- (a) To become a Registered Referee, a candidate shall approach his Club Secretary and President, who (when they consider that the candidate has achieved a satisfactory standard) shall recommend in writing to the nearest registered Referee Examiner on the prescribed form that the candidate be given a practical and oral examination. When the candidate has passed this examination to the Examiner's entire satisfaction, the Examiner will then submit his recommendation plus the form to the ACTA Executive Director, who will issue a Referee badge to the candidate. Any candidate who has failed and wishes to be re-examined must be re-examined by the same Examiner.
- (b) The Rules Supervisors will keep a record of all Referees in their State.
- (c) The Club Management complaint of any Referee or Referee Examiner shall be referred to the nearest Rules Supervisor within the State for investigation. The Rules Supervisor has the power to suspend the person concerned until the State Association Meeting. If justified, the State Association has the power to further suspend and recall the Referee or Referee Examiner's badge and shall advise the ACTA Executive Director of the action taken.
- (d) Referees shall be appointed for a period of five (5) years and are eligible for re-examination. Any Referee or Referee Examiner who fails to remain a financial member in any year will have his name automatically removed from the Association Referee and Referee Examiner list.

- (e) The Referee's decision in all cases coming under his jurisdiction as set forth in the rules shall be final. Referees are requested to wear their official badge at all shoots.

#### **11.16 DUTIES OF REFEREES**

- (a) The Referee, besides attending to special duties set forth in these rules, shall adjudicate the competition, he shall distinctly and loudly announce the result of each shot by calling out "one" when the target is broken. He shall decide all other issues which arise in relation to the direct competition.
- (b) If the Referee is negligent, or inefficient, impairing thereby the equity of the competition, the Management may forthwith remove him. This rule applies also to Scorers, target release operators, trappers and any other of the staff.
- (c) The Referee is empowered to challenge the ammunition used by any competitor.
- (d) The Referee has power to alter his decision. If altering his decision on "lost target" or "balk" etc, during the competition, this must be done before the shooter in question shoots his next target or the shooter leaves the tracks should this be his last target.
- (e) **The officiating Referee MUST have a trap checked and if required adjusted immediately, if in the opinion of the majority of the competitors in the squad, it is not throwing legal targets.** Immediately following such alteration, a target must be thrown and the competition continued. Unauthorised shooters are not to interfere with or attempt to interfere with the setting of the trap. Violation of this rule may be grounds for disqualification from the event.
- (f) He must have complete knowledge of the Sporting Clays rules of the ACTA and shall adjudicate the competition at all times as set by the Management.
- (g) It is his responsibility to announce the conditions as set out in the rules for each event before the competition commences, also to deploy shooters to their correct firing station.
- (h) As shooting proceeds he must observe that shooters are on their correct station, not shooting out of turn, are handling their guns with safety, and using the correct cartridges as laid down for each individual event.
- (i) The Referee must be efficient and alert at all times and it is most important that he should gain the confidence and respect of each and every competitor.

#### **11.17 DUTIES OF A SHOOT MARSHAL**

- (a) He must observe all the duties of the Official Referee.

- (b) He must be present at all shoot-offs.
- (c) He must see that all traps are checked for correct height and angles during competition and prior to shoot-off.
- (d) The Shoot Marshal shall be in charge of all operations and personnel relating to the shoot and shall be responsible only to the Management. A Shoot Marshal cannot over-rule the Referee's decision (See Rule 11.15)
- (e) He must instruct and roster the duties of all personnel prior to the commencement of each day's shooting.

#### **11.18 DUTIES OF REFEREE EXAMINER**

- (a) To examine applicants to become Referees who have been recommended as required in the ACTA Shooting Rules.
- (b) To assess the applicant's temperament, fairness, his ability to control a situation and his personal behaviour on the shooting tracks as a shooter before considering an examination.
- (c) To observe the actions of existing Referees on the shooting ground and to discuss any problems or make any recommendations considered appropriate.
- (d) To make himself available when convenient to attend rules discussions when required by clubs.

#### **11.19 DUTIES OF RULES SUPERVISOR**

- (a) A maximum of two suitable qualified persons appointed by the relevant State Association until such time as they may elect to resign or alternatively are replaced by their State Association. Rules Supervisors must be selected from experienced Referee Examiners who have held that position for a minimum of three years.
- (b) To examine applicants theoretically and practically for the position of ACTA Trap, Skeet and Sporting Referee Examiner and to advise the ACTA when the applicant is successful. Also to examine, or arrange for applicants to be theoretically and practically tested for the position of ACTA ISSF Referee Examiner and to advise the ACTA when the applicant is successful. Maximum of one ISSF Referee Examiner per State to be appointed.
- (c) Prior to the applicant attaining the status of Referee Examiner, an applicant must have completed a three year term as an official ACTA Referee.
- (d) To observe the actions of existing Referee Examiners and Referees and to discuss any problems concerning their duties.
- (e) To investigate the written complaint of any Club Management or Referee Examiner concerning the ability of existing Referees and to report to the appropriate State Association when action is considered necessary, with full facts so that the State Association concerned may recommend the action to be taken.



- (f) To investigate the written complaint of any Club Management concerning the ability of any Referee Examiner and to report the facts to the appropriate State Association concerned, so that the State Association concerned may recommend the action to be taken.
- (g) To arrange or require the re-examination of any Referee Examiner or Referee when considered necessary.
- (h) A Rules Supervisor should not generally carry out Referee examinations but may do so if requested or if there is no Referee Examiner in the area.
- (i) To make themselves available when convenient to attend rules discussions when requested by clubs. To make themselves available to attend the Bi-Annual Rules Supervisors meeting.
- (j) To keep an up to date list of current Referees within their State and to arrange for their re-examination prior to the expiry date.
- (k) To investigate any serious breaches of these Shooting Rules when requested in writing by Club Management or individual members, and to provide a written report of the findings (if considered necessary) to the relevant State Association for action.
- (l) To adjudicate on the interpretation of these Shooting Rules within their State when requested by Club Management or individual members.
- (m) To have applicants examined (by any means the Rules Supervisor determines) on their understanding and safe use of a Release Trigger device before the applicant can use a Release Trigger device at any ACTA affiliated Shooting Ground.

#### **11.20 REFEREE AND SCORER**

- (a) The Scorer shall keep an accurate record of each shot, according to the Referee's call. He shall mark the figure 1 or 0 relative to the Referee's call. If the Scorer is incompetent at scoring, the Referee has the right to change the Scorer before commencement or during the event.
- (b) All malfunctions, faulty cartridges or misfires must be recorded on the score sheet as "M" for malfunction, "R" for all refusals.
- (c) The official score must be kept on a score sheet and be available for inspection by the competitor.
- (d) It shall be the responsibility of the competitor to check his score with the score sheets before leaving the shooting ground. Any protest on his score must be lodged with the Referee immediately, ie before leaving the shooting ground. Such protest can only be made against incorrect score.

#### **11.21 BREAK RECOGNITION**

- (a) Break Badges will be recognised in sequences of 25, 50, 75, 100, and so on, provided these are shot in regular competition on one day only, excepting over a program of two or more successive days.

- (b) Clubs must submit form number 17, duly completed, to the ACTA, with the prescribed fee for each requested badge, before recognition can be considered or granted. Break badges, once they have been obtained, will not be repeated.
- (c) Break badges are available for all breaks up to and including the break, in the recognised sequence, as a result of any one break.
- (d) Shoot-off targets will only be recognised if they conform to the format of the event and provided that they are shot over an approved layout.

## **11.22 LONG BREAK RECORDS**

- (a) By an Australian – may be established either in Australia or overseas providing all criteria are met. These long break records may only be established by an Australian citizen.
- (b) In Australia – may be established by any shooter competing in Australia under ACTA rules. These long break records may only be established in Australia.
- (c) Long break records will only be recognised if shot over an advertised program and the shooter has finished his event.
- (d) Any tournament from club level upwards can be used for the purpose of establishment of long break records.
- (e) All applications for recognition of a long break record established in Australia must be accompanied by proper verification and submitted on the official ACTA form (available upon request). All applications for recognition of an Australian record established outside of Australia, besides the verification, must also have proof that all other conditions such as trapsetting were identical to the ACTA regulation standards.
- (f) Once a long break record is established the competitor's name shall be recorded in the appropriate category together with the long break record score. Any competitor who subsequently equals this score shall have his name recorded alongside the current record holder(s). Any competitor who subsequently betters this score shall have his name entered as the record holder together with the new long break record score and the previous holder(s) name(s) and score(s) shall be deleted.
- (g) The National Office shall keep a complete list, both past and present, of record holders and their scores, together with the dates established.
- (h) Any dispute over the recognition of any long break record shall be referred to the Executive Committee, whose decision shall be final.

### Examples of Five-Stand Sporting Layouts

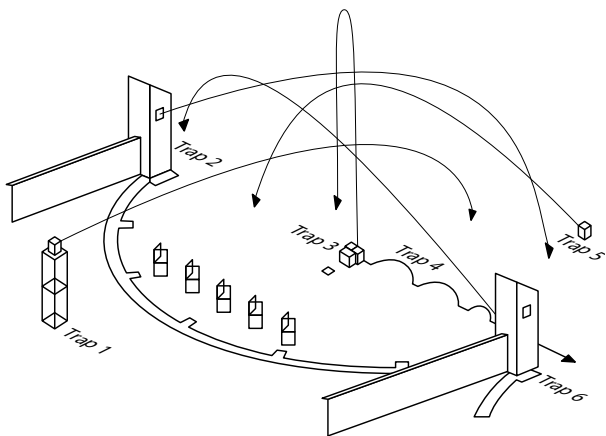
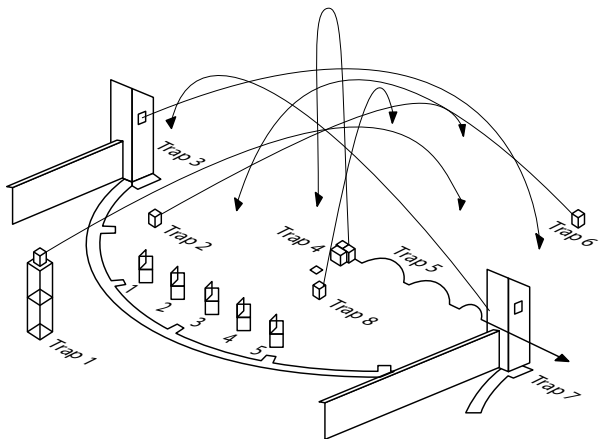



---

# **ACTA ENGLISH SPORTING**

---

# GENERAL INDEX — ACTA ENGLISH SPORTING

Duly Notified 20.09

Malfunction on single target 20.12

No target 20.14

Number/order of shots at target 20.11

Penalty 20.10

Report pairs 20.15

Sequence 20.01

Scoring pairs 20.13

Shooting Positions 20.08

Targets 20.02

— Single target 20.02

— Report pair 20.04

— Following pair 20.05

— Simultaneous pair 20.06

Tie break

— Individual 20.16

— Team 20.17

Trajectories 20.07

Viewing Point 20.00

# TECHNICAL RULES FOR ENGLISH SPORTING

To be read in conjunction with MANDATORY REQUIREMENTS FOR OFFICIALS, SPORTING CLAYS, ENGLISH SPORTING & SPORTRAP page 100.

## 20.00 VIEWING POINT

Any competitor who has not had an opportunity to see targets on any stand, i.e. at the commencement of the competition each day, shall have the right to see one target from each trap for that stand from a position outside the stand. All competitors should avail themselves of the opportunity to view targets whilst waiting their turn to shoot.

## 20.01 SEQUENCE

- (a) Targets may be thrown as singles, report pairs, following pairs or simultaneous pairs. No alteration is to be made to either the target or sequence of targets on any stand once a competition has begun.
- (b) Targets will be thrown by non-verbal and non-visible instruction by the Referee after the competitor has called for the target.

## 20.02 TARGETS

FITASC targets (Mini, Midi, Battue, Rocket, Helice and Rabbit targets) may be used, as well as Standard or 'Flash' ISSF targets. The total amount of FITASC targets shall not exceed 40% of the total number of targets in the competition. Targets may be of any colour.

## 20.03 SINGLE TARGET

A single target launched from any trap.

## 20.04 REPORT PAIR

Is a pair where the second target is launched at the sound of the gun firing at the first target.

## 20.05 FOLLOWING PAIR

Is a pair where the second target is launched from the same trap as soon as it is safely possible after the first target.

## 20.06 SIMULTANEOUS PAIR

Is a pair where both targets are launched simultaneously from either one or two traps.

## 20.07 TRAJECTORIES

At each stand, the trajectories shall be the same for each competitor in

height, distance and speed. It must be possible for all the targets to be hit within the effective range of a 12-bore shotgun. Before a competition management will establish a scheme for the trajectories of targets: These trajectories, established and calculated in calm weather, may be altered by wind, but if so altered, will remain regular targets.

#### **20.08 SHOOTING POSITIONS**

- (a) The competitor must remain positioned within the area of the shooting stand and is only allowed to load cartridges into the gun within the confines of the stand. The gun will at all times be kept pointing down the range and targets will only be called for after the Referee has given the signal to start. In no case may a Competitor move to the stand before the preceding competitor has left the stand and it is their turn to shoot.
- (b) Shooting stands shall be clearly defined squares no smaller than 0.91 metres and must be within an enclosure. Enclosures must be a minimum height of 2 metres, to prevent any safety problems when addressing or firing at any targets presented. The sides of any enclosure should not prevent the Referee from having a clear view of the competitor.

The recommended dimensions of the enclosure follow the standard Sportrap enclosure size of:

1200mm x 1200mm area with a removable front bar at 600mm height (to allow disabled competitors access and position) with enclosure sides to 2 metres and a padded top bar centrally above the pad. Front entry and variations on the size of the recommended enclosure will remain acceptable provided the arc of fire is contained within the exclusion zone.

#### **20.09 DULY NOTIFIED**

A competitor is “Duly Notified” to compete when their name is called out by a Referee, Scorer or other person authorised to do so. If a competitor is absent after being called, the Referee shall call the name on the score sheet loudly three times equally spaced within one minute. If the competitor is still not present, they will be “Declared Absent” and their score sheet will be marked accordingly with a two target loss.

#### **20.10 PENALTY**

If a competitor is declared absent, they will be penalised two targets by the Management and given the opportunity to shoot the remainder of the targets on that stand at the Management’s discretion.

#### **20.11 NUMBER/ORDER OF SHOTS AT TARGETS**

Two cartridges may be fired at a single target, but the Competitor will not be allowed to load more than two cartridges for firing at each pair.



## **20.12 PROCEDURE FOR MALFUNCTION ON SINGLE TARGET**

If after firing the first shot at a single target, a gun or cartridge malfunction occurs (providing it is not the third or subsequent malfunction on that stand) and the target has not been hit, the Referee shall instruct the competitor to reload their gun with two cartridges. The competitor will then be instructed to call for a new target but to miss with the first shot and attempt to hit the target with the second shot. If the new target is hit with the first shot it will be declared lost.

## **20.13 SCORING RE PAIRS**

- (a) In simultaneous pairs the competitor has the right to shoot either of the targets first. Should the Competitor hit both targets together with either the first or second shot; the result will be scored pair scored.
- (b) In any regular pair the competitor having missed the first target may fire their second cartridge at the same target, the result being scored on the first target, the second target being counted as lost unless the shot breaks both targets.

## **20.14 NO TARGET**

A “No Target” will be called and a new target will be launched, the shooter having fired or not providing:

- (a) The target is broken at the start.
- (b) The target is launched from the wrong trap.
- (c) Two targets are launched simultaneously when a single should have been thrown.
- (d) The target is denitely of another colour than the targets used for the competition on at that stand.
- (e) The first or second target of a pair is irregular.
- (f) The targets are launched simultaneously for a report pair or a following pair (i.e. two or more targets released).
- (g) The target is launched before the Competitor has called for it.
- (h) The target is launched after a delay of more than three seconds.
- (i) The target zigzags, or its initial speed is insufficient or if its trajectory is irregular.
- (j) The Competitor shoots at the first target and this target collides with the second before the Competitor has fired their second shot.
- (k) In the case of a “No Target” in simultaneous or following pairs the competitor will be asked to fire at a second pair to determine the scores of the two shots.
- (l) This will also apply in the case of a malfunction of gun or ammunition not attributable to the Competitor, provided that it is not the third time on that stand.
- (m) The Referee may also order the launching of a new target when:
  - (i) The competitor has been baulked, ie any extraneous occurrence, which in the opinion of the Referee materially interferes

with the equity of the competitor after he calls for his target constitutes a baulk.

- (ii) Another competitor fires at the same target.
  - (iii) The Referee cannot decide for any reason if the target has been hit or lost.
- (n) The Referee cannot in any case give a “No Target” if the competitor has missed for any reason other than those stated in the “No Target” rules.

## **20.15 REPORT PAIRS**

When a second target of a report pair is declared “No Target” the result of the shot at the first target will stand and the competitor will be asked to repeat the pair to determine the result of the second target.

- (a) When re-shooting the pair, the competitor must make a reasonable attempt to hit the first target before attempting to shoot at the second target.
- (b) Referees must ensure that competitors adhere strictly to rule 7.15(a). If a violation of rule 7.15(a) takes place, the Referee shall ask the competitor to repeat the pair (1st target established). If the Competitor violates rule 7.15(a) on three occasions, then at the third occasion the second target will be declared “lost”.

## **20.16 INDIVIDUAL TIE-BREAK**

- (a) In the event of a tie, whenever practicable and in accordance with the Management’s instructions, a tie-break will decide the Winner. The ‘count back’ system shall not be used at ACTA Registered events.
- (b) Ties will be broken by shooting initially at five pairs from a stand(s) decided by the Management. Scoring will be one point per target, making a total of ten.
- (c) If a tie still exists following the above, five pairs from a different stand will be shot at. Scoring will again be out of ten.
- (d) If a tie still exists, a “sudden death” tie-break on pairs will follow (scoring out of two) until the tie is broken. All competitors must shoot at an equal number of pairs.

## **20.17 TEAM TIES**

If two or more teams obtain the same scores, the Captain of each team shall nominate three members of their team to take part in the tie-break. The Captain may include themselves as one of the three.

All nominated team members must be present at the start of the tie-break. Incomplete teams will be disqualified.

The team order shall be decided by the tossing of a coin and each team member will shoot at a pair of targets from a new stand (not used at any other stage of the event). The first member of each team will shoot. They

will be followed by the remaining team members in rotation, until all have shot and the total score for each team is determined. Should a tie still exist then the procedure will be repeated until the tie is broken.



---

# **ACTA SPORTRAP**

---

# GENERAL INDEX — ACTA SPORTRAP

Layouts 21.00

Conduct of events 21.02

Malfunctions 21.03

Shooting doubles 21.04

Shooting singles 21.03

Tie break — Individual 20.06

# TECHNICAL RULES FOR SPORTRAP

To be read in conjunction with MANDATORY REQUIREMENTS FOR OFFICIALS, SPORTING CLAYS, ENGLISH SPORTING & SPORTRAP page 100.

**21.00** Except as detailed below all the above rules and regulations for English Sporting are fully applicable to the ACTA discipline of 'SPORTRAP'.

## 21.01 LAYOUTS

- (a) A 'Sportrap' layout will consist of 5 stands within safety enclosures set side by side in a straight line and numbered 1 to 5 starting from the left when viewed from behind the stands.  
Shooting stands shall be clearly defined squares of 0.91 metres sides.
- (b) To allow for wheelchairs, safety enclosures will measure 1200mm x 1200mm + 50mm.
- (c) Stands will be set at 3 metres to 3.3 metres centres.
- (d) Entry to and exit from all stands will be from the rear of the enclosure only and all enclosures will be fitted with a removable restraining bar at the front at a height of 600mm + 100mm. This bar may only be removed at the request of a wheelchair user and at all other times at the discretion of the Referee.
- (e) Five or more traps clearly identified starting from the left when viewed from behind the stands, to be placed anywhere the Management decides, set to throw targets specified in rules 21.01(d), (e), (f), (g). Each trap position must be clearly indicated by its own letter in the vicinity of the trap that must be visible from all stands.
- (f) 'Menu' boards in front of each stand, measuring a minimum of A4 size, 300mm x 210mm, will list the traps in the order in which they will be released at that stand.
- (g) When two or more layouts are installed in adjacent positions, there should be a minimum distance of 35 metres between stand no. 5 on one layout and stand no. 1 on the next.
- (h) A minimum exclusion zone of 205 metres in every direction in which shooting is likely to occur must be provided in front of every layout and in full accordance with standard ACTA safety regulations.
- (i) If any traps are placed near the competitors or spectators, or will send a target into those same areas, consideration must be given to ensure the safety of all concerned.

## 21.02 CONDUCT OF EVENTS

- (a) Squads will consist of up to a maximum of five competitors and only one competitor shall shoot at any one time.

- (b) The competitors comprising the squad shall stand within the designated shooting cages marked 1 to 5, in the same order in which their names appear on the official score sheet. All guns at this stage must be open and empty.
- (c) A “Round” will comprise of twenty-five targets as detailed below. Competitions may be made up of a multiple number of rounds on the same layout or different layouts.
- (d) At each stand, each competitor will shoot at single target (full use of the gun) plus one pair on report (O/R) or following (FOL), plus one simultaneous pair (SIM). A total of five targets per stand.
- (e) Any squad that has not had a chance to view the flight of the targets may request the Referee to show one individual target from each trap in alphabetical order.

### **21.03 SHOOTING SINGLES**

- (a) When all is ready and correct the Referee shall call “competition”. At that point, all competitors may load two cartridges, but their guns must remain open.
- (b) Competitor No. 1 shall then close their gun and, when ready, call for the target. The first target on the menu board shall then be released. The competitors will then fire at this target at any point within the designated area with either one or two shots. The resulting score (1 or 0), as determined by the Referee will then be recorded.
- (c) After the result of the previous shot has been established, competitor no. 2 will then follow the same procedure, followed in turn by competitors nos. 3, 4 and 5.

### **21.04 SHOOTING DOUBLES**

- (a) After competitor No. 5 has shot the single target, competitor No. 1 shall again call for a target which will be a double as per the menu board in front of the stand.
- (b) Shooting will then continue in the same format as in 21.04(a) until all competitors have shot at all their five targets in that stand.
- (c) At this point, the Referee shall call loudly and clearly “Unload and Change” competitors Nos.1 to 4 will then move to the next stand on their right whilst competitor No. 5 will walk behind and to the left to Stand No.1. All guns must be opened and empty when moving between stands.
- (d) When all competitors are ready, the Referee shall call “competition”. competitor No.1, who will be standing at Stand 2, will then re-commence the round and the procedure detailed above in 21.02(b) through 21.04(b) will start all over again.
- (e) When all members of the squad have shot at all the targets in every stand, the round will be finished and the Referee shall call loudly “Unload and check your scores”. At this point, all guns shall be opened and emptied before the shooters turn to leave their stands.



## **21.05 MALFUNCTIONS**

Shooters will be allowed up to two gun or ammunition malfunctions, not attributable to them, in each round without being penalised. The third or subsequent malfunction in the same round shall be counted as lost or pair lost.

## **21.06 INDIVIDUAL TIE-BREAK**

- (a) If two or more competitors obtain equal scores, precedence for the first three places in championships (and in other competitions where this has been announced in the program) are decided by a tie-break of twenty-five target rounds until a difference in scores occurs.
- (b) If after one round (i.e. fifty targets) a tie still exists, the remaining tied competitors will go into a “sudden death” shoot-off.
- (c) The “sudden death” tie-break will consist of the remainder of the tied competitors shooting from stand 3, one single target, followed by a report pair and a simultaneous pair. Should a tie still exist, the same variety of targets will be shot at from stand 4, and then stand 5. Should a tie still exist after stand 5 has been shot, then tied competitors shall start again at stand 3 and continue the same rotation until a winner is determined. At all times competitors must shoot at an equal number of targets.

# ACTA STATE HANDICAPPERS

## NATIONAL HANDICAPPER

Mr Ray Peatling  
Ph: 0429 434 547  
Email: rayhp@bigpond.com.au

## NEW SOUTH WALES:

John Maxwell (Deniliquin)  
Ph: 0429 873 373  
Email: jamshaz1@bigpond.com

## NORTHERN TERRITORY

Ray Niven  
Ph: 0438 873 790  
E: raymeg1@bigpond.com

## QUEENSLAND

Mr Brian Muirson  
Ph: 0419 776 608  
Email: brian.muirson@claytarget.com.au

## SOUTH AUSTRALIA

Mr Barry Pobke  
Ph: 08 8572 3813  
Email: bapobke@bigpond.com

## TASMANIA

Jo Francis  
Ph: 0438 019 959  
Email: paul.jo.francis@bigpond.com

## VICTORIA

Mr Ray Peatling  
Ph: 0429 434 547  
Email: rayhp@bigpond.com.au

## WESTERN AUSTRALIA

Tracy Forward  
Ph: 0417 993 172  
E: forwardtracy@hotmail.com

## **ACTA CONTACT DETAILS**

PO Box 466, Wagga Wagga NSW 2650

Phone: (02) 6938 2121 Fax: (02) 6931 0125

Website: [www.claytarget.com.au](http://www.claytarget.com.au)

### **NATIONAL OFFICE**

**Judy Ferry, Accounts**

email: [accounts@claytarget.com.au](mailto:accounts@claytarget.com.au)

**Aileen Storey, CTSN**

email: [ctsn@claytarget.com.au](mailto:ctsn@claytarget.com.au)

**Sue Vesperman, Membership**

email: [membership@claytarget.com.au](mailto:membership@claytarget.com.au)

**Aileen Storey, Media, Marketing & Facilities**

**Co-ordinator**

email: [admin@claytarget.com.au](mailto:admin@claytarget.com.au)

**Reception/Shoot Results**

email: [info@claytarget.com.au](mailto:info@claytarget.com.au)

# **STATE ASSOCIATION CONTACT DETAILS**

## **New South Wales**

**SECRETARY**

Kathleen DAWE

PO Box 1003

WAGGA NSW 2650

TEL: 02 6931 9980

FAX: 02 6931 9981

[www.nswcta.org](http://www.nswcta.org)

Email: [nswcta1@bigpond.com](mailto:nswcta1@bigpond.com)

## **Northern Territory**

**SECRETARY**

Nadine Katarski

PO Box 2082

PARAP NT 0804

TEL: 0416 102 335

Email: [ntctasecretary@gmail.com](mailto:ntctasecretary@gmail.com)

## **Queensland**

**SECRETARY**

Debbie YOUNG

GPO Box 947

BRISBANE QLD 4000

TEL: 0419 880 080

FAX: 07 5597 7699

[www.claytargetqld.org.au](http://www.claytargetqld.org.au)

Email: [admin@claytargetqld.org.au](mailto:admin@claytargetqld.org.au)

## **South Australia**

**SECRETARY**

Deb McPherson

PO Box 1430

Murray Bridge SA 5253

TEL: 0411 615 369

Email: [secretary@sacta.com.au](mailto:secretary@sacta.com.au)

[www.sacta.com.au](http://www.sacta.com.au)

# **STATE ASSOCIATION CONTACT DETAILS**

## **Tasmania**

**SECRETARY**

Alan Styles

PO Box 259

GEORGETOWN TAS 7253

TEL: 0439 522 711

Email: [secretary@tcta.com.au](mailto:secretary@tcta.com.au)

## **Victoria**

**SECRETARY**

Jeff Bell

PO Box 259

Drouin VIC 3118

MOB: 0409 358 636

[www.vcta.com.au](http://www.vcta.com.au)

Email: [vctasecretary@dcsi.net.au](mailto:vctasecretary@dcsi.net.au)

## **Western Australia**

**SECRETARY**

Anita Dyas

PO Box 761

COLLIE WA 6225

MOB: 0488 777 175

Email: [secretary@wacta.net](mailto:secretary@wacta.net)

[www.wacta.net](http://www.wacta.net)



# **GRADING/HANDICAP PERCENTAGES**

## **TRAP**

- AA 97% and over
- A 94% and under 97%
- B 90% and under 94%
- C under 90%

*Minimum handicap marks are tied to grades*

- AA 21 metres    A 19 metres
- B 17 metres    C 15 metres

## **SKEET**

- AA 97% and over Handicap 0
- A 94% and under 97% Handicap 1
- B 90% and under 94% Handicap 2
- B 87% and under 90% Handicap 3
- C 82% and under 87% Handicap 4
- C under 82% Handicap 5

## **SPORTING**

- AA 85% and over
- A 75% and under 85%
- B 65% and under 75%
- C under 65%

## **DOUBLE RISE**

- AA 92% and over
- A 84% and under 92%
- B 76% and under 84%
- C under 76%

## **BALL TRAP**

- AA 93% and over
- A 82% and under 93%
- B 70% and under 82%
- C under 70%

## **TOWER**

- AA 98% and over
- A 96% and under 98%
- B 91% and under 96%
- C under 91%

## **ISSF**

- AA 91% and over
- A 86% and under 91%
- B 78% and under 86%
- C under 78%

